

HQ AMARA™₂₀

USER MANUAL

VERSION 1.0



HQ AMARATM 20

USER MANUAL

VERSION 1.0



© 2017 Handi Quilter, Inc. All rights reserved.

The information contained in this document is subject to change without notice. If you find any problems in the manual, please report them to us in writing. This document is not warranted to be error-free. Handi Quilter, Inc. assumes no responsibility or liability for any errors or inaccuracies that may appear in the informational content contained in this manual.





Handi Quilter®, HQ Amara™, HQ Studio2 Frame™ and Pro-Stitcher® are either trademarks or registered trademarks of Handi Quilter, Inc. Digital tensioner U.S. Patent No. 8,997,669.

Printed in the United States of America.

Version 1.0 12/2017

How to Use This Manual

Special Information

-  **NOTE:** A NOTE indicates important information that helps you make better use of your Handi Quilter product.
-  **IMPORTANT:** An IMPORTANT note provides information that is essential to properly using your Handi Quilter product.
-  **CAUTION:** A CAUTION indicates a potential for causing harm to your quilting machine, the quilt, or to yourself.
-  **ONLINE:** Indicates there is more information online, such as a video.
-  **QUILTING TIP:** Handi Quilter educators share tips to get you started quilting.

Finding Information

What are you looking for?

Find it here

Warranty Information.....	<i>User manual</i>
Safety Information.....	<i>User manual</i>
Regulatory Information	<i>User manual</i>
What’s Included with your Machine	<i>User manual</i>
Machine Specifications.....	<i>User manual</i>
Frame Setup Information	<i>HQ Studio2 Frame installation manual</i>
Machine Setup Information	<i>User manual</i>
How to Thread your Machine.....	<i>Quick reference card</i>
Needle System for your Machine	<i>Quick reference card</i>
Getting Started with Quilting	<i>Getting Started videos - USB stick</i>
Online Videos	<i>www.HandiQuilter.com/videocatalog/</i>
Basic Maintenance	<i>User manual</i>
Troubleshooting	<i>User manual</i>
Tips and Tricks	<i>www.HandiQuilter.me/HQ-Live</i> <i>www.HandiQuilter.com/videocatalog/</i>
Training and Education Options.....	<i>www.HandiQuilter.me</i>
Customer Care/Technical Support.....	<i>1-877-MY-QUILT (697-8458) or 801-292-7988</i> <i>Available 8:00 AM to 5:00 PM Mountain Time, Monday to Friday</i> <i>HQcares@HandiQuilter.com</i>
Community.....	<i>Forum: www.HandiQuilter.me/forum/</i> <i>Blog: www.HandiQuilter.me/blog</i> <i>Facebook: www.facebook.com/HandiQuilter</i>
Non-English versions of this manual (when available)	<i>www.HandiQuilter.com/manuals/</i>

Contents

How to Use This Manual	2
Congratulations on Your Purchase!	5
What's Included With Your Machine.....	5
Important Safety Information (English)	5
About Your Machine	9
General Specifications.....	9
Get to Know Your Amara.....	10
Installation and Setup	13
Carriage.....	13
Power Cord.....	14
Front Handlebars.....	14
Optional Accessory: Rear Handlebars.....	18
Touch-Screen Displays.....	19
Thread Tray and Thread Mast.....	21
Optional Accessories.....	21
Using Your Machine	25
Power Switch.....	25
Lighting.....	25
Magnetic Tool Minder Collar.....	25
Machine Needle.....	25
Hopping Feet.....	27
Optional Accessory: Handi Feet.....	28
Bobbin and Bobbin Tension.....	29
Easy-Set Tension™.....	31
Threading the Machine.....	32
Quilting With the Amara	34
Preparing to Quilt.....	34
Free-Motion Quilting.....	35
Micro Quilting.....	35
Optional Computer-Guided Quilting: Pro-Stitcher®.....	36
Using the Touch-Screen Displays	38
Overview of the Main Screen.....	39
Stitching Modes.....	41
Toolbar Options	46
Controlling the Lights.....	46

Machine Tools 47
 Quilting Timer, Alarm, and Stitch Counter..... 47
 On-screen Calculator 49
 Software Updates 50
 Diagnostics 52

Machine Settings 53
 Low-Bobbin Alarm 53
 Handlebar Button Options 55
 Laser Lights..... 58
 Alarms 58
 Tie-offs..... 59
 Set Language 60

Information Screens 60

Machine Maintenance..... 63
 Clean and Oil Your Amara..... 63
 Maintenance Schedule..... 64

Troubleshooting 65

Appendix 1..... 70
 Federal Communications Commissions (FCC) Declaration of Conformity (For USA Only)..... 70
 Canadian Department of Communications Compliance Statement (For Canada Only)..... 70
 Radio Interference (Other than USA and Canada) 70

Warranty 71

Warranty Registration Card 73

Machine Setup and Training Checklist and Certificate 75

Congratulations On Your Purchase!

You haven't just purchased a quilting machine, you've joined the Handi Quilter family and we welcome you. You have acquired the most advanced quilting machine available in today's market.

Handi Quilter is committed to innovation, reliability, customer service, and education. Our machines are *Designed by a Quilter, for Quilters*® and we are committed to your quilting success. With that in mind, we invite you to bookmark our website: www.HandiQuilter.me and invite you to visit to learn more about the art of quilting. We've posted videos on subjects as diverse as *Oiling Your Machine* to *Loading a Quilt* to *Making Perfect Feathers*. Your new quilting friends are already there, waiting for you! Remember, if you ever have questions, your local HQ authorized representative can help you. If the representative is not available, contact Handi Quilter directly at HQCares@HandiQuilter.com or by calling us, Monday through Friday, 8:00 AM to 5:00 PM Mountain Time (1-877-697-8458 or 1-801-292-7988).

Keep the carton and packing materials. You will need them if you need to return the machine to the retailer or send it for repair. If you don't pack the machine properly or if you don't use the correct packaging materials, the machine could be damaged. Handi Quilter is not liable for damage that occurs during return shipping.

- **IMPORTANT:** These packaging materials are designed to prevent the machine from being damaged. Keep them in case you need to bring this machine to the dealer or send it for repair.

What's Included With Your Machine

- Bobbins (5 pieces)
- Bobbin Case
- Needle (134) size 100/16 (pack of 10)
- Needle (134) size 110/18 (pack of 10)
- Thread tray and thread mast
- EZ Pen Oiler
- Power Cord
- Screwdriver
- 2 mm hex wrench
- 2.5 mm hex wrench
- 3 mm hex wrench
- 5 mm hex wrench
- Open-toe Handi Foot (Ruler foot installed)
- Handlebar button stickers (2)
- Quick Reference Card
- HQ Bobbin Winder
- Handlebar button stickers (2)
- HQ Amara Quilting Machine (including carriage, front handlebars, front display, handlebar cable)

Important Safety Information

This device complies with Part 15 of the FCC Rules. Operation is subject to the following two conditions: (1) This device may not cause harmful interference, and (2) this device must accept any interference received, including interference that may cause undesired operation. See the full Declaration of Conformity in the Appendix.

- **IMPORTANT:** Do not operate your HQ Amara quilting machine until you have completely read the information contained in this manual. Please keep all packaging and order information for warranty purposes.

IMPORTANT SAFETY INSTRUCTIONS

Read all instructions before using this machine.

When using this machine, basic safety precautions should always be followed, including the following:

DANGER — To reduce the risk of electric shock:

- A quilting machine should never be left unattended when plugged in. Always unplug the machine from the electrical outlet immediately after using and before cleaning.

WARNING — To reduce the risk of burns, fire, electric shock, or injury to persons:

- The HQ Amara is heavy. Never attempt to lift it alone. Always use two people when lifting. Always lift from the throat of the machine, not from the handlebars.
- Always unplug the HQ Amara from the electrical outlet when performing any maintenance, changing the needle, removing thread locks, or when left unattended.
- Do not unplug by pulling on cord. To unplug, grasp the plug, not the cord.
- Keep fingers away from all moving parts. Use caution around the needle or sharp external components.
- Change the needle often. Do not use bent or dull needles. “Every quilt deserves a new needle”.
- Switch the machine to the symbol off, or 0, position to turn it off when making any adjustments in the needle area, such as threading needle, changing needle, threading bobbin, changing hopping foot, and so forth.
- Never drop or insert foreign objects into any opening.
- The HQ Amara should only be used indoors away from moisture.
- The HQ Amara should not be stored or used in extreme temperatures.
- Use the HQ Amara only for its intended use as described in this manual.
- To disconnect from the wall outlet, push the switch to the off position, then remove the plug from outlet pulling from the plug, not the cord. Never operate the HQ Amara if the cord is damaged or not working correctly. If a mechanical or electrical problem is encountered, return the HQ Amara to the nearest authorized service center or the manufacturer for examination, repair, electrical, or mechanical adjustment.
- It is not recommended that the HQ Amara quilting machine be used with any machine quilting frame other than those recommended by Handi Quilter.
- Use this quilting machine only for its intended use as described in this manual. Use only attachments recommended by the manufacturer as contained in this manual.
- Never operate the machine with any air openings blocked. Keep ventilation openings of the machine free from the accumulation of lint, dust, and loose cloth.
- Do not operate where aerosol (spray) products are being used or where oxygen is being administered.
- Do not pull or push the machine across the fabric excessively while stitching. It may deflect the needle enough to cause it to break.
- Use only needles designed for free motion quilting and recommended by Handi Quilter for this machine. Other types of needles may be break during normal quilting.
- Children shall not play with the machine. Close attention is necessary when this machine is used by or near children.

- This sewing machine may be used by children age 8 years and above and persons with reduced physical, sensory, or mental capabilities or lack of experience and knowledge if they have been given supervision or instruction concerning use of the machine in a safe way and understand the hazards involved.
- Cleaning and user maintenance shall not be made by children without supervision.

Save these instructions

This machine is intended for household or commercial use.

Disclaimer

Handi Quilter and its Representatives are in no way legally responsible or liable for damage to the HQ Amara when used improperly or not in accordance with the guidelines stated in this manual or when used on machine quilting frames not recommended by Handi Quilter.

To use the machine safely

1. Carefully watch the needle when sewing. Do not touch the hand wheel, take up lever, needle, or other moving parts.
2. Turn the machine off and unplug the cord in the following cases:
 - when you have stopped using the machine
 - when you replace or remove the needle or any other part
 - when you check or clean the machine
 - when you leave the machine unattended
3. Connect the machine directly to the wall outlet or to a surge protector that connects directly to the wall outlet. Do not use extension cords.

To increase the life of your machine

1. Do not store this machine in areas exposed to direct sunlight or high humidity. Never use or store the machine near a heater, an iron, a halogen lamp or other hot things.
2. Use only neutral soaps or detergents to clean the machine. Benzene, solvents and scouring powders can damage the case and the machine and therefore should never be used.
3. Do not drop or bump the machine.
4. Always consult the manual to replace or fix the hopping foot, needle or any other part of the machine. If necessary contact an authorized Handi Quilter representative or Handi Quilter technical support.

Optional U.S. Grounding for Customers with 120 VAC Connections

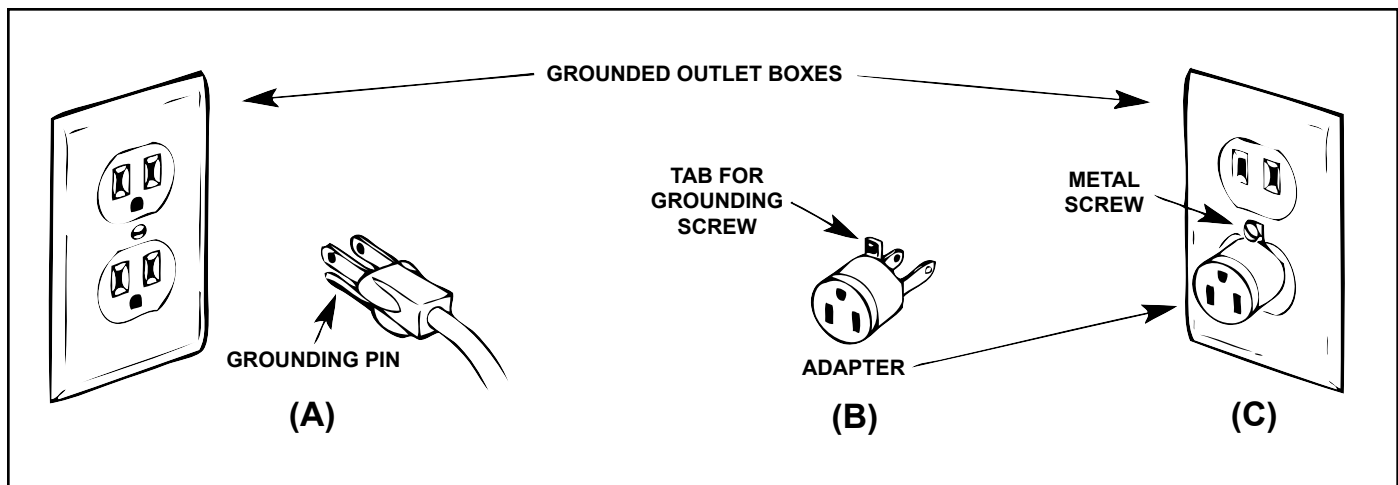

This product is for use on a nominal 120 V or nominal 220 V circuit, and has a grounding plug that looks like the plug illustrated in sketch A above. A temporary adapter, which looks like the adapter illustrated in sketches B and C, may be used to connect this plug to a 2-pole receptacle as shown in sketch B if a properly grounded outlet is not available. The temporary adapter should be used only until a properly grounded outlet can be installed by a qualified electrician. The green colored rigid ear, lug, and the like, extending from the adapter, must be connected to a permanent ground such as a properly grounded outlet box cover. Whenever the adapter is used, it must be held in place by the metal screw.

➡ **IMPORTANT:** In Canada, the use of a temporary adapter is not permitted by the Canadian Electric Code.

To repair or adjust the machine

If the machine breaks down or needs adjustment, first check the troubleshooting chart in the appendix to inspect and adjust the machine yourself.

For more product information and updates, visit our website at www.HandiQuilter.com.

The contents of this manual and product specifications are subject to change without prior notice. Check for updated manuals at www.handiquilter.com/manuals/.

About Your Machine

General Specifications

The HQ Amara uses high-tech electronics and an innovative touch-screen user interface to offer greater functionality and ease of operation to home quilters than ever before conceived in the quilting industry. The HQ Amara quilting machine is a high quality machine that both incorporates robust design features and is easy to service.

Sewing Opening Dimensions	(228 mm X 521 mm) 9 inches X 20.5 inches
Sewing Speed	Manual Mode: from 25 stitches per minute to 2500 stitches per minute Regulated Mode: from 0 stitches per minute to full speed
Stitches Per Inch	4 stitches per inch to 24 stitches per inch Basting mode: one stitch per quarter inch, one stitch per half inch, one stitch per inch, one stitch every two inches, and one stitch every four inches
Needle System	134
Needle Sizes (recommended)	From 80/12 to 130/21
Hook System	Rotary, Horizontal Axis, M-class bobbin
Bobbin Type	Aluminum, Class M
Bobbin Case	Type MF
Motor Type	Brushless DC
Needle Positioning	Up and down, walking stitch, on-screen hand wheel
Electrical Power	100-240 VAC, 50-60Hz, 1.5-3.3A This machine conforms to UL and international safety standards for sewing machines and US and international laws for electromagnetic compliance.
Outlet Power	120 watts maximum
Sew Foot Stroke/Lift	5 mm
Needle Bar Stroke	35.3 mm
Take-Up Stroke	73 mm
Lubrication, main components	Kluber Lube, permanent
Lubrication of hook	Velocite 10, Texaco 22

Get to Know Your Amara

Left side view (picture shown with optional rear handlebars)

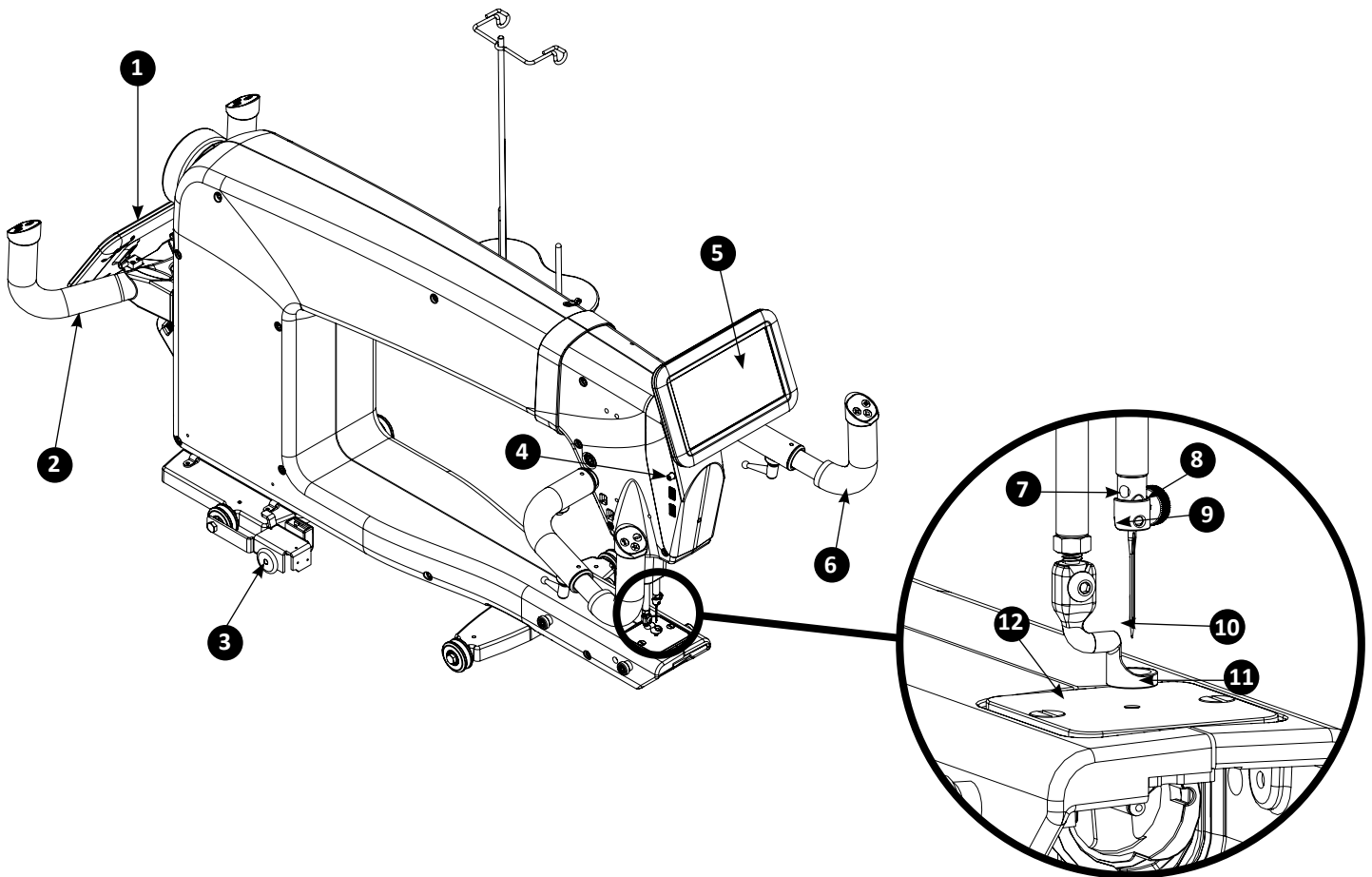

1. Rear display (optional accessory)
2. Rear handlebars (optional accessory)
3. Machine "Y" encoder
4. Front on/off switch
5. Front display
6. Front handlebars

Close-up view of needle area

7. Needle stop/sight hole
8. Needle bar clamp screw
9. Needle bar thread guide
10. Needle
11. Ruler foot
12. Needle plate

Right side view (picture shown with optional rear handlebars)

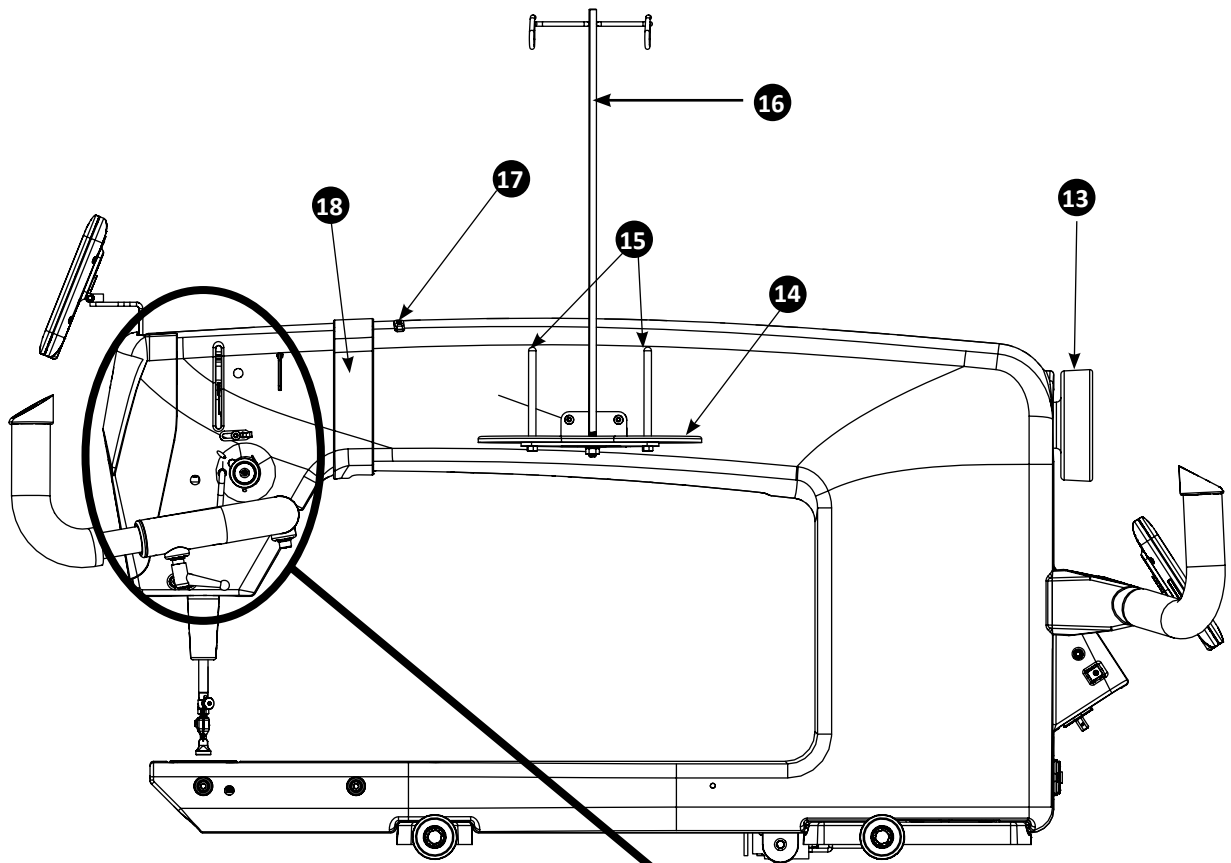

- 13. Hand wheel
- 14. Thread tray
- 15. Spool pins
- 16. Thread mast
- 17. Thread guide
- 18. Magnetic Tool Minder Collar

Close-up view of tension assembly area

- 19. Three-hole thread guide
- 20. Thread guide
- 21. Top tension assembly with take-up spring
- 22. Thread stirrup
- 23. Take-up lever
- 24. Thread break sensor
- 25. Lower thread guide

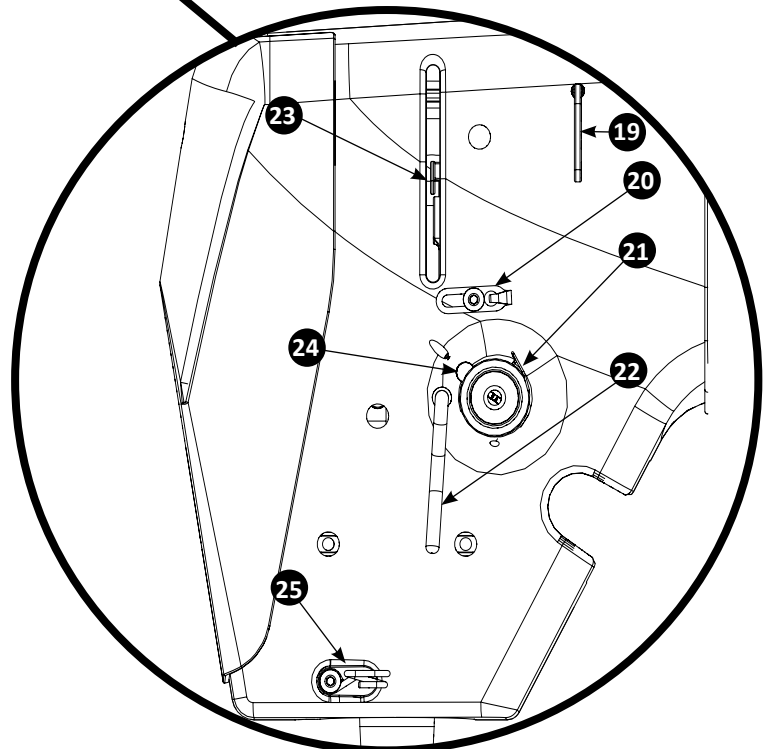

Back Panel (picture shown with optional rear handlebars)

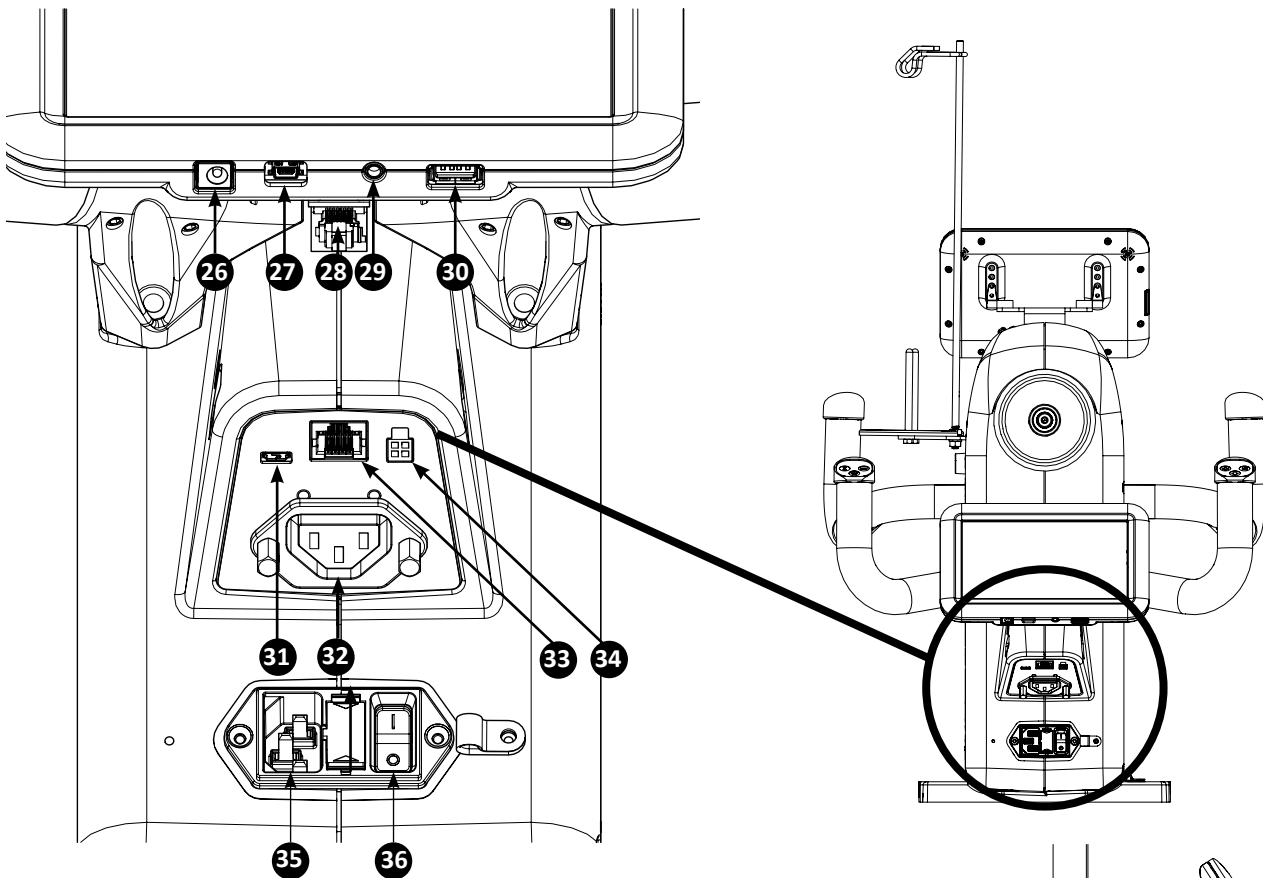

Display Connections

- 26. Rear display power outlet (not used)
- 27. Rear display power and communication (#25 to #29)
- 28. Rear handlebar to machine connection (#26 to #31)
- 29. Rear display audio (not used)
- 30. USB stick connection (for updating rear display)

Machine Connections

- 31. Machine rear display connection (#29 to #25)
- 32. Machine power connection
- 33. Machine to handlebar connection (#31 to #26)
- 34. Machine to Pro Stitcher communication
- 35. Auxiliary power
- 36. Main on/off power switch connection

Rear Side Connections

- 37. X carriage encoder connection (top)
- 38. Laser connection (bottom)
- 39. USB auxiliary power connection (bottom)
- 40. Y machine encoder connection (top)

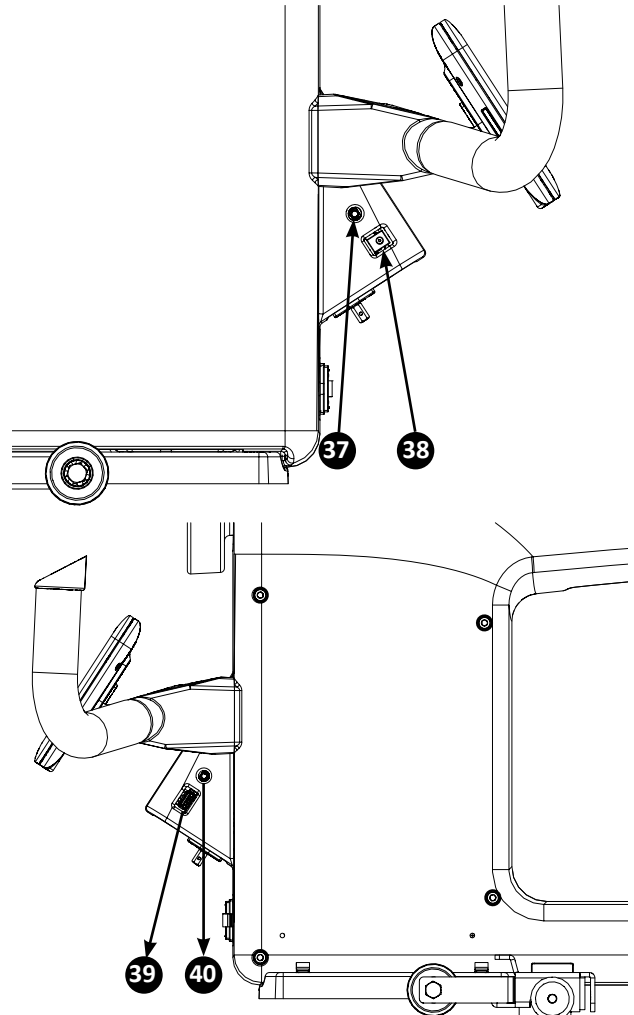

Installation and Setup

Carriage

You should have already set up the HQ Studio2 Frame™. Refer to the frame manual for detailed instructions about setting up the frame.

- **IMPORTANT:** Make sure the frame is set up for a 20-inch machine, not an 18-inch machine.

To install the carriage and machine on the frame

1. Place the carriage on the table rails, ensuring that the stitch regulator faces the back of the frame.
2. Place the machine on the carriage.
 - △ **CAUTION:** The HQ Amara is heavy. Never attempt to lift it alone. Always use two people when lifting. Always lift from the throat of the machine, not from the handlebars, needle bar area or needle bar.
3. From the back of the machine, plug the carriage stitch regulator cable into the top round jack on the left hand side of the machine.

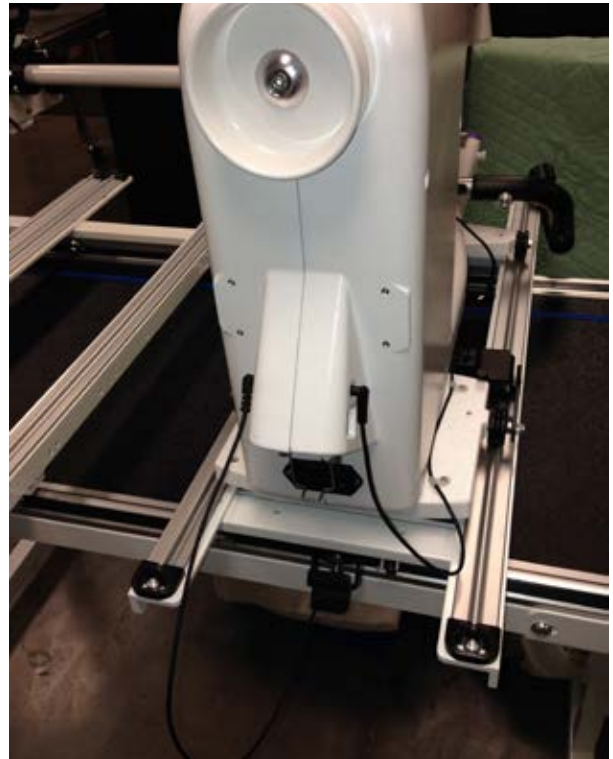

- **IMPORTANT:** If you ever need to remove the machine from the carriage, disconnect the stitch regulator cable from the machine. Failure to unplug the cable when removing the machine from the carriage could result in damage to the cable, encoders, and carriage.

Power Cord

To install the power cord

- Insert the cord into the power connector on the rear of the machine. Plug the three-prong end into power source. Do not turn on the machine until the handlebars and display are installed.

To disconnect the power cord

- Push in on the red buttons on the end of the cord that connects to the machine; then pull out the cord.

For more information, see *Power Switch* in the *Using Your Machine* section of this manual.

-  **NOTE:** Make sure that the machine is off before plugging into a power source. The rear power switch should be in the 0, or off, position.

Front Handlebars

The Amara comes with handlebars at the front of the machine. Optional back handlebars are available for pantographs and Groovy or pattern boards. The front handlebars will be used for most other quilting activities. The front handle bars can be independently adjusted. This allows you to have one handle up and the other down or adjust them to any number of variable positions.

For more information about using the touch-screen displays, see *Using the Touch-Screen Displays* later in this section of the manual.

-  **CAUTION:** To prevent any electrical damage to the handlebars, always turn off all power to the machine when connecting or disconnecting the handlebars.

To install the front handlebars

1. Locate the special cone shaped wedge, the M6 x 45mm hex screw and 6mm flat washer.



-  **IMPORTANT:** Four handlebar lever bolts are provided for you to use and come pre-assembled on your handlebar. These enable you to easily hand-loosen the handlebars to adjust the angle of the handlebars to switch between regular quilting and micro quilting.



4. From the front of the machine, bring the handlebar set up into the “U” shaped slot in the machine casting located behind and below the top tension assembly.



5. Looking through the hole found on the left side of the machine just above the “U” shaped cutout, locate and align the threaded hole on the handlebar bracket.



6. Place the wedge and M6x45 hex screw with washer into hole and start the screw into the threaded piece with your fingers. Once the screw is nicely started into the handle bar, firmly tighten the screw with the provided 6mm socket tool.



7. Connect the handlebar’s USB mini B cables into the side of the machine. Connect the longer cable coming from the handlebar to the bottom connector on the machine and the shorter cable to the closer upper machine connector.



8. Each side of the handlebar can be individually adjusted forward or backward to a comfortable position for quilting. Loosen and tighten the handlebar lever bolt closest to the machine body. Fully hand-tighten the levers once in the desired position. Each side can also be adjusted in and out and rotated up or down as desired using the lever closest to the handle control switches.



➡ **IMPORTANT:** See *To attach labels to the handlebars* in the section *Configurable Handlebar Buttons* below.

To adjust the hand-position angle of the front handlebars

Rotate the angle of the handlebars to a comfortable position by using the two levers below the handlebars.

📺 **ONLINE:** For more information about adjusting the front handlebars, watch the video *Adjusting the Handlebars* at: <http://www.HandiQuilter.com/Amara/handlebars>.

- Loosen the levers by turning them counterclockwise. Then grasp the front of the handlebars and adjust them inward or outward to a comfortable position. Tighten the levers by turning them clockwise when you are happy with the position.

To use the handlebars for micro quilting

📺 **ONLINE:** For more information about adjusting the front handlebars for micro quilting, watch the video *Micro Quilting* at: <http://www.HandiQuilter.com/Amara/microquilting>.

When micro quilting, you'll want to have your hands (and therefore, handlebars) close to the quilt top. In addition to adjusting the angle of the handlebars, you can adjust the distance from the quilt.

- Use the back handlebar lever bolt to loosen the handlebar that you would like to adjust. Grasp the handlebar and tilt it closer to the quilt until it is at a comfortable position. Repeat with the other handle as desired. Then tighten the handlebar lever bolt.

🔧 **NOTE:** The handle bar lever bolt is spring loaded and can be pulled out and located in a different position if desired.

Configurable Handlebar Buttons

The Amara handlebars are configurable; you can decide which functions you want the buttons to operate. Once configured, the front and back handlebars work the same.

The machine comes from Handi Quilter configured to have the right handlebar control starting and stopping quilting, and increasing stitching speed in Manual mode or stitches per inch in Regulated mode. The left handlebar controls cycling the needle up and down, and slowing the stitching speed or decreasing stitches per inch. However, you can switch the functions from one side to the other when you set up your machine. You can also select from several functions and assign one to the star button and another to the diamond button. For example, choose to have the diamond button perform a tie-off and the star button perform another desired function.

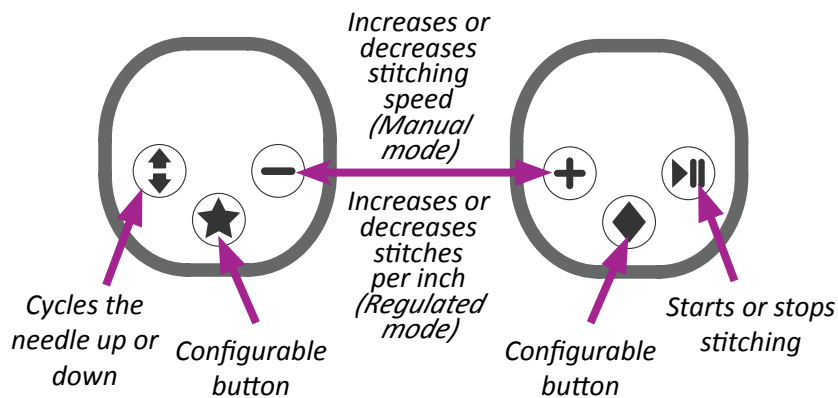

For more information about configuring the handlebars and buttons, see *To customize the handlebar buttons* in the *Toolbar Options* section of this manual.

Install the handlebar labels according to what you want each handlebar to do. For example, if you are left-handed, you may want the left handlebar to control starting and stopping the stitching.

 **NOTE:** The traditional handlebar configuration has the Start and Stop buttons on the right handlebar and the Needle Up and Down buttons on the left handlebar.

To attach labels to the handlebars

 **CAUTION:** Be absolutely certain of your handlebar label choice before installing the labels. Once they are stuck down they cannot be removed without damaging the switch.

1. Peel off the paper backing off the labels and place them on the front handlebars according to how you plan to configure the functions.
2. Repeat for the optional rear handlebars, making sure that you match the placement from the front handlebars.

Optional Accessory: Rear Handlebars

 **ONLINE:** For more information about installing the rear handlebars, watch the video *Quilt from the Back Kit* at: <http://www.HandiQuilter.com/Amara/QFTB>.

1. Locate the four 4mm hex screws for the rear handlebars and the 4mm hex wrench.

2. Align the four holes in the handlebars with the holes on the back of the machine.

3. Slide the bolts into holes until they stop. Use the 4mm hex wrench to firmly tighten the bolts and securely fasten the handles to the back of the machine.

4. Connect one end of the RJ45, or network style, phone cord into the handlebars and the other end into the machine's back panel.

5. Install the back handlebar display to the handlebar with the four small screws using the 2.5mm hex tool.

Connect the USB mini B connector to the back of the machine. You will need the other end for the display later. Note that this cable powers the display, the round power input to the display is not used.

 **IMPORTANT:** See *To attach labels to the handlebars* in the *Configurable handlebar buttons* topic below.

 **NOTE:** After installing and plugging in the handlebar(s) and the touch-screen display(s), plug in the power cord and test them by turning the machine on, using the rear power switch and then the power button on the front left side of the machine. If nothing appears on the touch screen(s), check that the handlebar cable(s) are plugged in securely, that your machine is turned on, and that the power cord is plugged into the machine as well as into a power source. If everything is working, turn off and unplug the machine and continue the installation.



Touch-Screen Displays

The Amara comes with one 7-inch touch-screen front display. If you have purchased the optional back handlebar, the display will be identical.

To install the front display

1. For the front display, locate the four 4-40 screws and a small Phillips screwdriver (not provided). You'll also need the display with the hinges attached to the bottom row of connectors on the back of the display.

2. Insert the 4-40 screws into the openings on the display's metal hinge. Align the screws in the hinge with the holes on the display bracket. Use the small Phillips screwdriver to fully tighten the screws.



3. Plug the USB mini B cable (with 90° connection), coming out of the top front cover, into the bottom of the display. This cable provides power and signal connection from the machine to the display. The USB connection on the bottom right of the display is used for updating the display and the machine software.



➤ **IMPORTANT:** Note the other connections on the bottom of the display for power and audio are not functional. Also the SD card slot on the left of the display is not used at this time.

➤ **IMPORTANT:** If you have Pro-Stitcher, you will install the Pro-Stitcher tablet computer to the front of the machine instead of the 7-inch display. See the instructions that come with Pro-Stitcher for more information about installing the tablet computer.

To install the optional rear display

 **ONLINE:** For more information about installing the optional rear display, watch the video *Quilt from the Back Kit* at: <http://www.HandiQuilter.com/Amara/QFTB>.

1. Locate four 2.5mm hex screws and the 2.5mm hex wrench. You'll also need a display with the hinges attached to the bottom row of connectors on the back of the display, plus the USB mini B cable with 90° connector on one end.

 **NOTE:** If you do not have 2.5mm hex screws then you will have 4-40 screws for the rear handle bar hinges.

2. Insert the screws into the openings on the display's metal hinge. Align the screws in the hinge with the holes on the display bracket. Use the 2.5mm hex wrench or Phillips screwdriver as required to fully tighten the screws.



3. Plug the USB mini B cable with 90° end into the rear display and the straight end into the rear panel of the machine.



Thread Tray and Thread Mast

To install the thread tray on the machine

1. Locate the two small M4x10mm hex button head screws and the thread mast assembly.
2. Align the screws in the thread mast bracket with the two holes in the side of the machine (top tension side). Use a 2.5mm hex tool to tighten the bracket firmly to the side of the machine.



Optional Accessories

Steady-Fit Ruler Base™

If you plan to use rulers and templates with the Amara, you will need to purchase the ruler base to give you a large, stable surface on which to rest the ruler or template. The ruler base and rulers and templates are optional accessories. For more information, visit <http://www.handiquilter.com>.

To install the ruler base

📺 **ONLINE:** For more information about installing the ruler base and using rulers, watch the video *Ruler Base Installation* at: <http://www.HandiQuilter.com/Amara/rulerbase>.

1. The Amara machine comes with four preinstalled mounts for the ruler base.
2. With the Steady-Fit Ruler Base™ tilted down about 30°, align the back ruler-base hooks with the machine mounts until they are about to catch, then lower the front of the ruler base until the front hooks align and catch also. With all four ruler-base hooks aligned and started onto the machine mounts, push the ruler base back into the final position.



To remove the ruler base

- Grasp the front corners of the ruler base, pull the ruler base towards you and then up on an angle off the machine.



To use rulers and templates with your quilting machine

- △ **CAUTION:** Use only 1/4 inch thick rulers with your machine. Do not use rotary-cutting rulers; they are too thin and can easily slip under the hopping foot. Always use the Steady-Fit Ruler Base™ to stabilize the ruler.

Keep the ruler flat and quilt only where the ruler is held securely. Avoid losing control by walking your hand along the ruler or stopping and repositioning your hand and/or the ruler.

- Quilting with rulers requires gentle three-point pressure as follows.
 1. Position and press the ruler against any side of the hopping foot.
 2. Press machine against ruler.
 3. Press ruler against ruler base with only as much force as is necessary to keep the ruler from slipping. Too much pressure will keep the machine from moving.

The quilting line will be approximately 1/4 inch away from the ruler edge. The markings on all Handi Quilter rulers take this into consideration.

- ✍ **NOTE:** Set the machine to stop in the needle-down position to keep the machine from moving while making adjustments with the ruler.

Rear Laser Stylus

The laser light (for use with pantographs) is installed on a mounting post. The post is threaded into a hole on the machine casting. The hole is found towards the back of the machine on the free arm about 3 inches in front of the rear wheel.

To install the mounting post and laser stylus

- 🔗 **ONLINE:** For more information about installing the optional rear laser light, watch the video *Laser Light* at: <http://www.HandiQuilter.com/Amara/laserlight>.

1. Locate the mounting post with nut and washer, the laser stylus, and the 8mm combo wrench.
2. Remove the nut and washer from the mounting post. Place the nut all the way onto the mounting post and then the washer (to protect the machine paint). Thread the post into the tapped hole on the machine all the way and then fix its position by tightening the nut.



3. Slide the laser clamp onto the mounting post and tighten the two knobs on opposite sides of the clamp.



4. Plug the laser cable end into the laser stylus port on the back of the machine. This is found on the tension side of the machine inset in the rectangular shaped opening.



The laser projects a straight laser beam visible as a dot on surfaces it hits. The laser dot is used as a guide or stylus enabling you to use printed pantograph designs and stitch the pattern onto a quilt by tracing the design with the laser dot.

The laser attaches to a mounting post which attaches to the machine. The laser stylus can move in any direction by rotating the clamp on the post and pivoting the laser up or down. To make an adjustment, simply loosen the black thumbscrews, position, and re-tighten.

- **IMPORTANT:** A label is attached to the laser's case and contains an arrow which indicates the direction of the laser light when energized. The label must remain in place on the laser. Removing the label voids the laser's warranty.

Laser Operation and Safety

Unplug the laser from the back of the machine to turn it off.

Be sure the laser is attached to the machine and pointed downward toward the table before connecting it to the port. Never point it in a direction that would project the beam into someone's eyes. If the laser should stop working, ensure the plug is firmly seated into the Amara laser port.

Laser Focus and Image Size

Focus the laser by turning the threaded housing surrounding the lens clockwise or counterclockwise. The laser image can be adjusted to project a bigger or smaller dot, or focal size. The direction of rotation needed is determined by the distance of the laser from the pantograph surface. Experiment by rotating the threaded end to achieve your desired focal size.

Laser Safety

When using the laser stylus, observe the following basic safety precautions.

- Never shine directly into the eyes.
- The laser stylus should never be left on and unattended.
- Do not use the laser stylus as a toy.
- Pay close attention when the laser stylus is being used by or near children or pets.
- Use the laser stylus only for its intended use as described in this manual.

 **NOTE:** If you can't see the threaded housing, the lens may be threaded too far into the laser body. You will need to use a large slotted screwdriver to turn it counter clockwise until the housing is visible. You can then rotate it with your fingertips to bring the light into focus. Be very careful to not scratch the lens when using the screwdriver.

 **CAUTION:** Use of controls or adjustments or performance of procedures other than those specified herein may result in hazardous radiation exposure.

Machine Head USB Port (included)

To be used to power accessories, NOT for programming, which is done through the USB port on the front display.

 **ONLINE:** To see how to use the machine head USB port, watch the video *Machine Head USB Port* at: <http://www.HandiQuilter.com/Amara/USBport>.

Horizontal Spool Pin

 **ONLINE:** To see how to install the horizontal spool pin, watch the video *Spool Pin* at: <http://www.HandiQuilter.com/Amara/spoolpin>.

Using Your Machine

Power Switch

There are two power switches for your machine. The main power switch is at the rear of the machine and another power switch is at the front of the machine for added convenience.

The machine is turned on when both switches are turned on. The machine is turned off when both switches are off. However, you may turn off the machine functions by turning off only the front switch if you will be returning to quilting within a day.

Turn on the back switch first by toggling the switch from the 0 position to the 1 position. Then turn on the front switch by pressing it. The front switch will not turn on the machine unless the back switch is already on.

- **IMPORTANT:** If you will not be using the machine for more than a day, we recommend you turn off both switches and unplug the power cord from the power source.
- **IMPORTANT:** Refer to the safety instructions.

Lighting

The Amara includes several lights to make it easy for you to see your quilting area: two lights under the throat of the machine that provide lighting to the quilting area and a light ring that illuminates the needle and stitching area. There is also a bobbin area light. Optional UV lights are available as an accessory for purchase. UV lights are helpful when you need to see white thread or white chalk on white fabric.

Turning the lights on and off is done through the touch-screen display. For more information about turning on the machine lights, see *To control the lights* on the machine in the *Toolbar Options* section of this manual.

Magnetic Tool Minder Collar

Use the left side of the collar to store steel tools, such as mini scissors, close at hand.

- 📺 **ONLINE:** To see how to use the magnetic tool minder collar, watch the video *Magnetic Tool Minder Collar* at: <http://www.HandiQuilter.com/Amara/toolminder>.

Machine Needle

Use only the recommended needle system for your Amara quilting machine. The machine was timed to use this specific type of needle (System 134) and it is designed to work with the high quilting speeds and multi-directional stitching the Amara offers.

The Amara uses the 134 needle system. Note that the needle has a round shank rather than a shank with a flat side like home sewing machines use.



If you use the recommended needle, you will experience:

- Fewer skipped stitches
- Less needle breakage
- Less thread breakage, especially at high speeds
- Less thread splicing or shredding
- Optimum fabric protection

🔄 **IMPORTANT:** Change the needle regularly. We recommend you use a new needle for each new quilt and any time the needle becomes bent, dull, or burred.

⚠ **CAUTION:** A damaged needle may result in poor stitching quality or may even damage the machine or your quilt.

To change the needle

📺 **ONLINE:** For more information about replacing the needle, watch the video *Replacing the Needle* at: <http://www.HandiQuilter.com/Amara/needle>.

1. Move the needle bar to the up position by pressing the needle up/down control on the handlebar.
2. Turn off all power to the machine.
3. Loosen the needle bar clamp screw with the 2.5mm hex wrench.

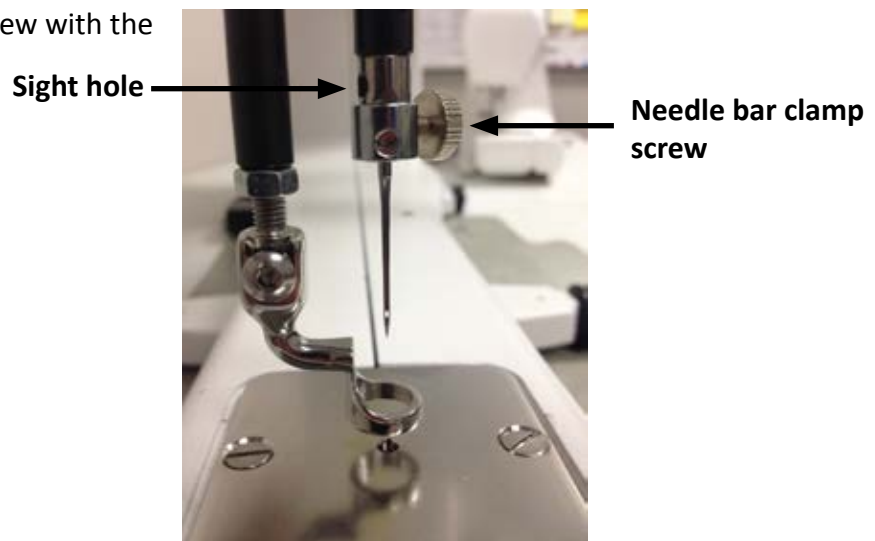

4. Remove the old needle by pulling it down. Discard the old needle in a safe way.

- With the scarf of the needle (indentation at the back of the needle just above the needle eye) facing the rear of the machine and the long groove down the front of the needle facing the front of the machine, push the needle all the way up into the needle bar until it stops. Check the sight hole in the needle clamp to verify that the top of the needle can go no farther up.



Scarf at back of needle just above eye



Long groove at front of needle - shoulder to eye

△ **CAUTION:** Check the needle to confirm it is fully inserted. The needle bar has a sight opening above the needle bar clamp screw. Make sure the needle is touching the top of the sight opening. If it isn't, the machine timing will be off and it may be possible for the needle to collide with internal parts causing damage not covered by warranty.

- Carefully tighten the needle bar clamp screw.

△ **CAUTION:** Although you can use your fingers to tighten the needle bar clamp screw, we recommend that after finger-tightening the screw you use the 2.5mm hex wrench to tighten it just a bit more. The Amara runs at very high speeds and this ensures the needle will not loosen while quilting. However, do not over tighten the needle clamp screw as this may strip the threads of the screw. Stripped threads are not covered under the warranty. It may also become difficult to insert the needle properly into the needle bar. Once the screw no longer turns freely by hand, gently turn the screwdriver until the screw is tightened snugly.

Needle Size	Thread Size
12 and 14	monofilament, 100 wt. silk, 60 wt. polyester, mylar
16	monofilament, mylar, 100 wt., 80 wt., 60 wt., 50 wt., 40 wt. silk, polyester and cotton thread
18	40 wt. cotton and polyester, 30 wt. cotton and polyester
19 and 21	Any thread 30 wt. and heavier such as 12 wt., 19 wt., 30 wt.

✂ **QUILTING TIP:** Needle requirements for general quilting, a size 16/100 needle will accommodate most threads and fabrics. Heavier threads, such as top stitch and some decorative threads, require a larger needle such as 18/110 or 21/130. Lofty batts and heavier fabrics such as denim, canvas, or densely woven fabric may also require a larger needle.

Hopping Feet

Your machine comes with two hopping feet: a ruler foot (comes installed) and an open-toe foot. Use the ruler foot for everyday quilting and ruler work, and use the open-toe foot when you need greater stitch visibility (such as when you are micro quilting).

📺 **ONLINE:** For more information about changing the hopping feet, watch the video *Changing Handi Feet* at: <http://www.HandiQuilter.com/Amara/handifeet>.

To change the hopping foot

1. Raise the needle and foot to their highest position. Remove the foot that is on the mount by using the 2.5mm hex wrench to loosen the mounting screw far enough that you can slide the foot off of the mount.
2. Slide the desired foot onto the mount. Note that the opening on the side of the foot is lined up with the screw hole. Push the foot up as far as it will go.
3. Fully tighten the screw with the 2.5mm hex wrench.

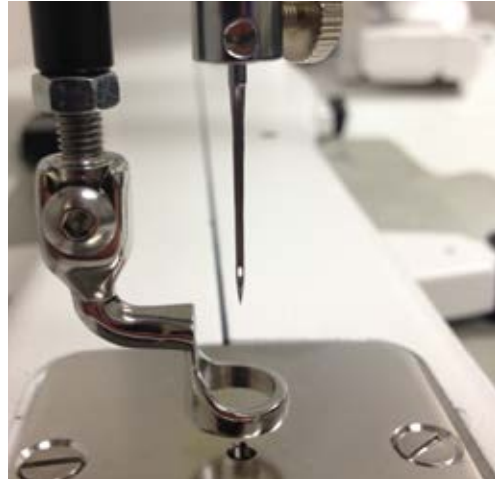

 **NOTE:** Before threading the needle, test that the machine is threaded properly and the tension is correct by carefully pulling the top thread. It should pull smoothly with light to medium tension. If thread pulls freely with no tension, re-thread the machine, ensuring that the thread is flossed into the tension discs.

 **IMPORTANT:** The Amara does not have a presser foot lever or top tension release like a home sewing machine. On a home sewing machine the top tension is released when the presser foot is raised, allowing the thread to come freely out of the machine. When a home machine is threaded the tension discs are released and open to allow the thread to easily fall between the tension discs. This isn't the case with the Amara quilting machine. The top tension is always engaged and the tension discs are never open. Therefore the thread must be pulled up, or flossed, between the tension discs or it will stay outside the discs and float without tension, causing serious tension problems and/or thread nests.

Optional Accessory: Handi Feet

 **ONLINE:** For more information about changing the Handi Feet, watch the video *Changing Handi Feet* at: <http://www.HandiQuilter.com/Amara/handifeet>.

 **ONLINE:** For more information about optional HQ Handi Feet, watch the *HQ Live video HQ Live - Mary Beth Krapil* at: <http://www.HandiQuilter.com/Amara/HQLiveMBK>.

Bobbin and Bobbin Tension

The Amara quilting machine uses M-class bobbins that are larger than home sewing machine L-class bobbins. The larger bobbins hold more thread and enable you to quilt for a longer time between bobbin changes.

The Amara also has a low-bobbin alarm. For more information about the low-bobbin alarm, see *To configure the low-bobbin alarm settings* in the *Toolbar Options* section of this manual.

To wind the bobbin

The Amara comes with a separate bobbin winder. For full instructions about using the bobbin winder, see the instruction manual that is packaged with the bobbin winder.

📺 **ONLINE:** For more information about using the bobbin winder, watch the video *Using the Bobbin Winder* at: <http://www.HandiQuilter.com/Amara/bobbinwinder>.

To insert the bobbin into the bobbin case

📺 **ONLINE:** For more information about inserting the bobbin and adjusting bobbin tension, watch the video *Bobbin Tension* at: <http://www.HandiQuilter.com/Amara/bobbintension>.

⚠️ **CAUTION:** To prevent personal injury always turn off the front power switch while inserting and/or removing the bobbin case or anytime your hands are near the needle area, such as when you change the needle.

1. Place the bobbin in the bobbin case so that the thread pulls off clockwise when viewing the open side.
2. Slide the thread through the slot and under the tension spring, leaving approximately five to six inches of thread hanging loose.



To test bobbin tension

The bobbin tension is the foundation for stitch tension. Always set the bobbin tension first.

✍️ **NOTE:** Check the bobbin tension each time a new bobbin is inserted.

1. With the bobbin properly in the bobbin case, hold the bobbin case in the palm of your hand with the open end facing up.

2. Wrap the thread two to three times around the index finger of the opposite hand and attempt to lift the bobbin up by the thread. The bobbin case should stand up on its side, and slightly lift out of your hand. If the bobbin will not stand up on its side, the bobbin tension is too loose. If it lifts completely out of your hand and hangs by the thread, the bobbin tension is too tight.

To adjust the bobbin tension

- Make the adjustment using the screw in the center of the tension spring. (The larger of the 2 screws) Turn clockwise to tighten and counterclockwise to loosen the tension. Make tiny adjustments to the bobbin tension and test again.



To insert the bobbin case into the machine

1. Move the needle to the up position. Turn off the power to the machine using the front button.
2. Place the bobbin in the bobbin case so that the thread pulls off clockwise when viewing the open side.
3. Slide the thread through the slot and under the tension spring, leaving 5 to 6 inches of thread hanging loose.
4. To fit the bobbin case onto the hook spindle in the machine, orient the bobbin case as shown in the photo with alignment notch to the right. Push the bobbin case inward until it clicks into place.



 **NOTE:** Do not insert the bobbin case into the machine by lifting the lever on bobbin case. Use the lever only for removing the bobbin case.

Easy-Set Tension™

One of the joys of quilting with the Amara is its ability to handle many different types of thread. You can quilt with almost any high-quality thread as long as you first adjust the bobbin tension and then adjust the top tension to suit the thread you've chosen.

Puckering, gathers, and thread breakage occur when the top tension is too tight. Loops and thread nests occur when the top thread tension is too loose. Tension may need to be adjusted depending on the fabric, thread, or batting you are using on the project.

 **NOTE:** Top tension should be adjusted after the bobbin case tension adjustment is made.

 **NOTE:** Dark threads will be thicker (because of dye) than light threads of the same weight and may require a tension adjustment. The type or brand of thread may also affect tension settings. Each time you change threads, you should check your tension.

 **ONLINE:** For more information about adjusting the top-thread tension, watch the video *Adjusting Top Tension* at: <http://www.HandiQuilter.com/Amara/toptension>.

 **IMPORTANT:** Before adjusting your top tension remember to floss the top thread up between the tension discs or it will float outside the discs providing little or no top tension. This could cause significant tension or thread nesting problems.

 **QUILTING TIP:** Test the tension settings before quilting. The best way to make sure the top and bottom tension settings are balanced is by quilting. Keep 4-inch squares of light solid fabric on hand to place at the side of the quilt on the extra batting and backing. Then quilt some loops and swirls and look at the stitches on top and underneath to ensure the tension looks good. Fine tune the tension as needed.

To adjust the top tension

1. Test stitching with a scrap of fabric placed on the extra batting and backing at the side of the quilt.
2. Adjust the tension by turning the tension dial clockwise to tighten and counter-clockwise to loosen. The tension value appears on the touch screen. The value changes as you turn the tension dial.
3. Continue to test the stitching on the fabric scrap and adjust by turning the tension dial until you are happy with the stitches.



Tension Quick Start Guide

Bobbin adjustments are minute, like ticks of the clock.

1. **Always adjust bobbin tension first.**
2. Stitch to check top tension.
3. If thread looks like Diagram A
Problem: The top thread is too tight.
Solution: Turn the top tension dial counter-clockwise to loosen the top tension.
4. If thread looks like Diagram B
Problem: The top thread is too loose.
Solution: Turn the top tension dial clockwise to tighten the top tension.

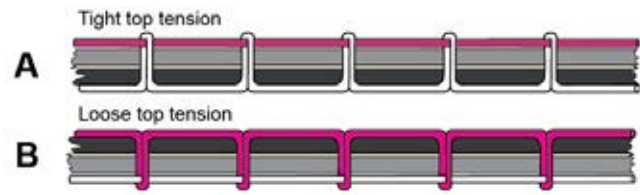
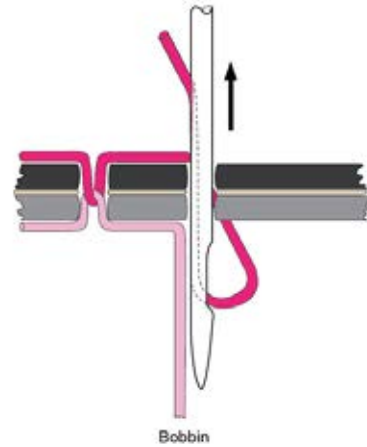

Threading the Machine

Handi Quilter recommends that you select and use only high-quality threads for your quilts.

To thread the machine

1. Place thread cone onto spool post ① on the thread tray, insert the thread through the thread-mast eyelet ② from back to front, continuing to the thread guide ③.
2. Continue to the three-hole thread guide ④. Wrap all three holes from back to front, being careful not to cross threads. This is recommended for most threads. However, some very delicate threads or metallic threads may require less tension. If you are having problems with thread breaking, try threading only one or two holes of three-hole thread guide.

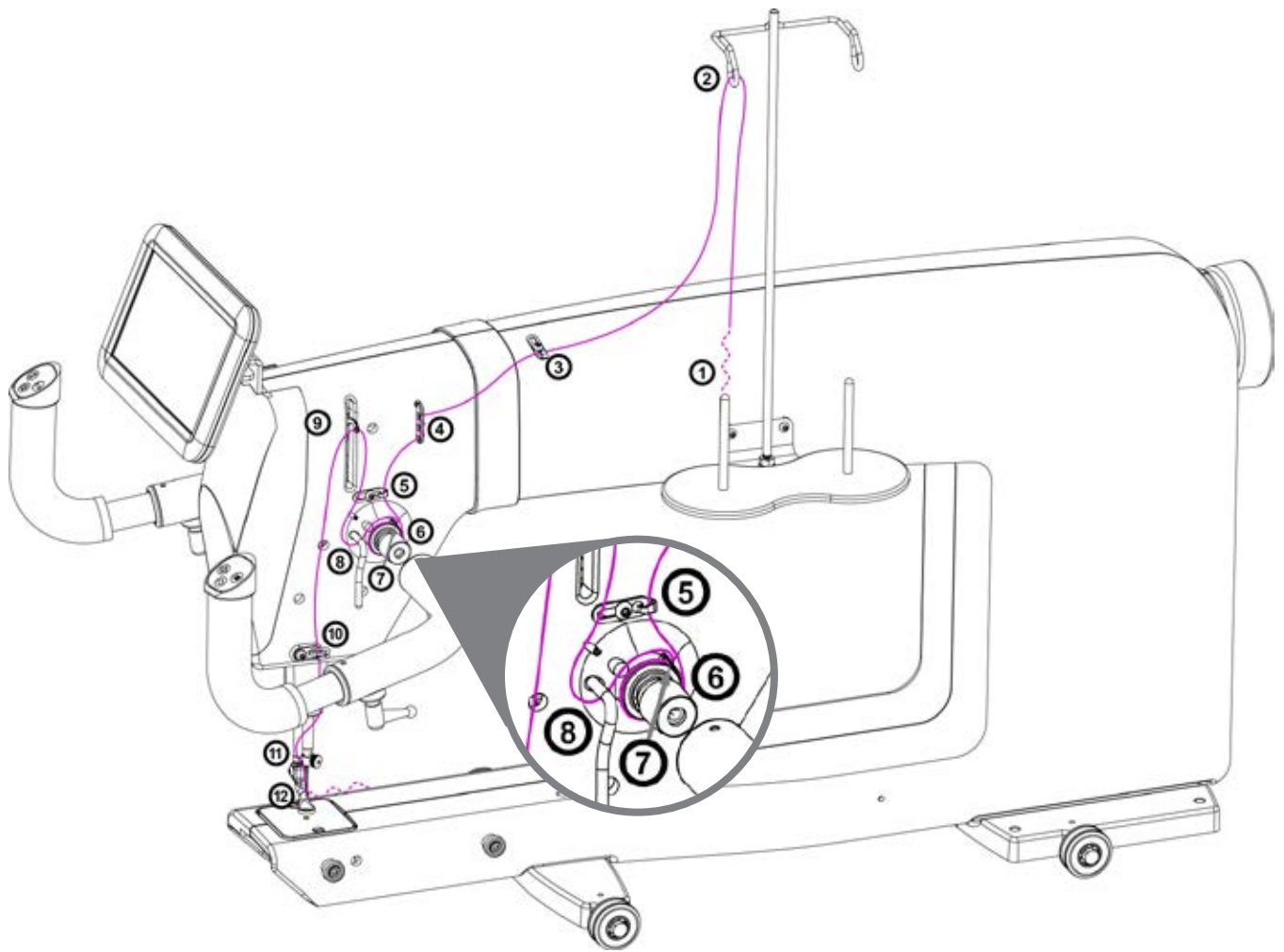

3. The thread continues down to thread guide (5) just above the top tension and then on to the top tension assembly (6).
 - ➡ **IMPORTANT:** The thread must be flossed up between the two tension discs. If the thread is not firmly in place between the two tension discs, the thread will lay on top of the tension discs (no tension) and thread looping on the bottom of the quilt can occur.
4. After the thread is in place, be sure that the thread catches on the take-up spring. Then guide the thread under the stirrup thread guide (8).
5. Bring the thread up and through the hole of the take-up lever (9) from back to front, and then through the pigtail thread guide (10), and thread through the needle bar thread guide hole (11).
6. Make sure the thread follows the groove down the front of the needle and insert the thread through the eye of the needle from front to back (12). While pulling thread through the eye of the needle be careful that the thread does not twist around the needle.

📺 **ONLINE:** For more information about threading the machine, watch the video *Threading the Machine* at: <http://www.HandiQuilter.com/Amara/threading>.

Quilting With the Amara

Preparing to Quilt

1. Make sure your machine has been cleaned, oiled, has a new needle, and that the tracks on the frame are free from threads or other debris. If the machine isn't already plugged in, plug it in now.
2. Select your thread and wind one or more bobbins.
3. Turn on the main power switch at the back of the machine and then use the front power button on the left side of the machine to turn the machine on or off as needed.
4. Set your bobbin tension and thread your machine.
5. After loading your quilt, use a scrap of fabric along the edge of the quilt backing and batting to test your top tension. Make adjustments to the top tension as needed.

To load the quilt

 **ONLINE:** For more information about loading the quilt using ClearView mode of the Quiltmaster™ DuoLoad system, watch the video *HQ Studio2 Frame ClearView Load* at: <http://www.HandiQuilter.com/HQStudio2/clearview>.

 **ONLINE:** For more information about loading the quilt using Standard mode of the Quiltmaster™ DuoLoad system, watch the video *HQ Studio2 Frame Standard Load* at: <http://www.HandiQuilter.com/HQStudio2/standard>.

To bring bobbin thread to the top of the quilt

 **ONLINE:** For more information about starting and stopping quilting and programming handlebar buttons, watch the video *Bringing Up the Bobbin Thread* at: <http://www.HandiQuilter.com/Amara/bobbinthread>.

1. After the machine is threaded, move the machine over the quilt to your starting location.
2. While firmly holding the tail of the needle thread, press the needle up/down button twice, causing the needle to go down through the quilt sandwich and then back to the up position.
3. Move the machine two to three inches while holding the needle thread in place. The bobbin thread will pull through to the top of the quilt.
4. Grasp the bobbin thread and pull it to the desired length. Reposition the needle to the starting location. Manually tie off the threads by quilting a few very tiny stitches or use the automatic Tie-off feature by pressing the Tie-off button on the Home screen and slightly move the machine. Press the Start/Stop button to begin quilting.

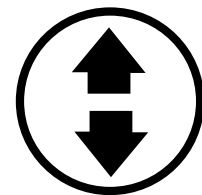

-  **NOTE:** If you have customized either the star or diamond button to do a tie-off, press that button on the handlebar instead. For more information about configuring the handlebar buttons, see *To customize the handlebar buttons* in the *Machine Settings* section of this manual.

To start or stop quilting

- Start or stop the machine at any time by pressing the Start/Stop button on the handlebars.



To tie off threads when starting and ending quilting

-  **ONLINE:** For more information about starting and ending quilting and programming handlebar buttons, watch the video *Programming Handlebar Buttons* at: <http://www.HandiQuilter.com/Amara/programminghandlebar>.

- Touch the **Tie-off** button on the Main screen to perform a tie-off. For more information about tying off your stitching, see *To configure automatic tie-offs* in the *Toolbar Options* section of this manual.



Free-Motion Quilting

-  **ONLINE:** For examples of different types of free-motion quilting, watch the video *Free-Motion Quilting* at: <http://www.HandiQuilter.com/Amara/freemotion>.

-  **QUILTING TIP:** When quilting, relax your hands and maintain a light touch on the handlebars. Gripping the handlebars too tightly may cause body tension resulting in poor quilting quality. The Amara, in combination with the HQ Studio2 Frame system, will give you a smooth even glide while quilting.

Micro Quilting

For more information about adjusting the front handlebars for micro quilting, see *To use the handlebars for micro quilting* in the *Installation and Setup* section of this manual.

-  **ONLINE:** For more information about micro quilting, watch the video *Micro Quilting* at: <http://www.HandiQuilter.com/Amara/microquilting>.

Optional Computer-Guided Quilting: Pro-Stitcher®

The Pro-Stitcher® quilting system integrates Handi Quilter's quilting machines with the best computer technology for computer-guided quilting using digital designs. The software is managed from a state-of-the-art tablet computer that is conveniently mounted on top of the machine. This rich and full-featured software is easy to learn and makes precise quilting simple and fun!

Using the Pro-Stitcher Tablet on Your HQ Amara

When you add Pro-Stitcher to your Amara, the Pro-Stitcher tablet computer replaces the front touch-screen display. The Amara display is integrated into the Pro-Stitcher tablet computer. The Amara software works the same as it did on the 7" display. However, when also using Pro-Stitcher, the Pro-Stitcher software sometimes overrides some of the Amara settings. For more information about how Pro-Stitcher works with the Amara, see the Pro-Stitcher user manual.

First turn on the Amara, then turn on the Pro-Stitcher tablet computer. Both the Pro-Stitcher software and the Amara application console start up.

 **NOTE:** After the Amara application console starts, it works the same as if you were running it from the smaller touch-screen display, as described in the *Using the Touch-Screen Displays* and *Toolbar Options* sections of the manual.

While the Amara and Pro-Stitcher are running, a menu appears in the upper left corner of the screen. Touch a button on this menu to switch between using Pro-Stitcher, using the Amara console, and using *Art & Stitch*. You can also open the on-screen keyboard, or close the menu from view.



Use Pro-Stitcher to quilt, or switch to free-motion quilting by disengaging the Pro-Stitcher gears. (In Pro-Stitcher, select **Pro Stitcher tab**, then **Gears button** to disengage the gears.)

Handlebar Star and Diamond Buttons with Pro-Stitcher

Four functions in Pro-Stitcher override your custom settings for the star and diamond buttons on the handlebars. When creating areas, the star button is 2-point and the diamond button is multi-point. When using Freehand Record, the star button starts and stops recording. When using Mark to create lines for quilting, the diamond button creates points on the line. See the Amara version of the Pro-Stitcher manual for more information about how the star and diamond buttons work with these functions.

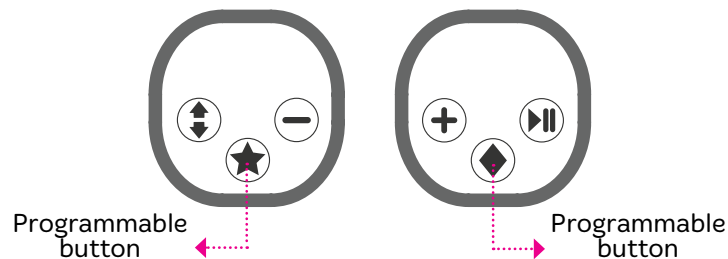

Updating the Amara Software

If you are running the Amara from a Pro-Stitcher tablet computer, the Update screen has only the machine icon. You will update the Amara machine software and the rear display using the Update option on the Tools menu. However, the Amara console application software is part of the Amara version of the Pro-Stitcher software. Make sure you are also using the latest version of the Pro-Stitcher software.



Using the Touch-Screen Displays

The Amara has touch-screen displays on the front and rear handlebars. They each work the same. For example, use the displays to alternate between stitch-regulated and non-stitch-regulated operation, to control settings for how you prefer your machine to operate, and to use tools such as counting stitches on a quilt or logging how much time it took to finish your quilt.

 **ONLINE:** For information about using the touch-screen display, watch the video *Using the Touch-Screen Display* at <http://www.HandiQuilter.com/Amara/display>.

 **NOTE:** If you have Pro-Stitcher, you should have installed the tablet computer that came with Pro-Stitcher at the front of the machine rather than the 7-inch touch screen. You will then use the Pro-Stitcher tablet to control the functions of the Amara.

Buttons are selected, or on, when they are green and display black text or graphics. Buttons are off when they are purple and display white or lighter gray text or graphics. When you touch a button, it will toggle on or off, open a pop-up box for you to enter information, or open a screen with more options.



If a button cannot be used, usually because another process is underway, it will be gray.

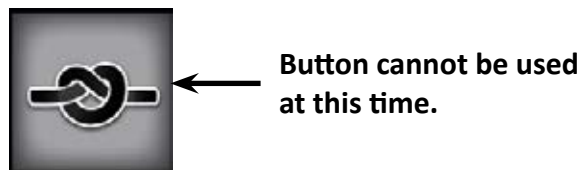

Overview of the Main Screen

The Amara main screen provides quick access to all functions.

These buttons → indicate whether or not your machine is stitching or paused. It is currently paused because the pause button is green, or on.



← This Toolbar appears on every screen to provide quick access to often-used options. When selected, the icons will be green, not white.



Touch this icon to open the Lights screen. For more information about turning lights on and off, see *Controlling the lights* in the *Toolbar Options* section of this manual.



Touch this icon to open the Tools. For more information about the various tools, see *Machine Tools* in the *Toolbar Options* section of this manual.



Touch this icon to open the Settings. For more information about the various settings, see *Machine Settings* in the *Toolbar Options* section of this manual.



Touch this icon to see system information, as well as a machine threading guide and needle/thread guide. For more information about the system information that is available, see *Information Screens* in the *Toolbar Options* section of this manual.

This area of the main screen controls the stitching modes. It is currently set to manual mode. It also shows the current stitches per minute setting and three stitches-per-minute presets. This area changes according to the stitching mode you've selected.



The on-screen hand wheel enables you to rotate the machine's hand wheel from the main screen rather than reaching around the machine to do it manually.

These buttons remain the same regardless of the stitching mode you choose.



Tie-off button: Use this button to perform a tie-off at the start or finish of your stitching. Touch the button and gently move the machine to perform the micro stitches. The number below the image indicates how many micro stitches will be performed.

For more information about how to configure the number of micro stitches in a tie-off, see *To configure tie-offs* in the *Toolbar Options* section of this manual.



Needle-stop button: Touch the button to alternate between having the needle stop in the up or down position when you press the stop/start button to stop stitching. Your choice displays in green.

This button does not move the needle, but rather indicates your preference for the final needle position when quilting is stopped.



Reset-bobbin button: Press this button after a bobbin change if you are using the low-bobbin alarm. This resets the low-bobbin reading to indicate you are using a full bobbin. The number on this button shows an estimate of how much thread remains on the bobbin. This number updates as you quilt. As the number gets closer to zero, the bobbin is running out of thread. For more information about the low-bobbin settings, see *To add a new bobbin configuration and record bobbin capacity* in the *Toolbar Options* section of this manual.

➔ **IMPORTANT:** Touch this button only to reset the bobbin capacity to indicate a full bobbin. If you want to open the Low Bobbin Alarm screen, select the **Machine Settings** toolbar button and then select the **Low Bobbin Alarm** screen.

To use the on-screen hand wheel



The on-screen hand wheel enables you to rotate the hand wheel from the Main screen rather than reaching around the machine to do it manually.

Drag your finger down from the top of the on-screen hand wheel (in the direction of the arrows) to cycle the needle bar and the presser bar.

 **NOTE:** You can, if necessary, move your finger in an upward motion to turn the hand wheel in the opposite direction. You'll typically do this only when you need to break a thread lock.

Stitching Modes

The Amara enables you to choose between two modes of stitch regulation Cruise or Precision; or to choose manual stitching. It also includes a basting mode.

Manual Stitching Mode

When using the manual stitching mode, the length of the stitch is determined by how quickly or slowly you move the machine, in combination with the number of stitches per minute (up to 2500) you have selected. For a consistent stitch length, you will need to move the machine at a consistent speed. Experiment with different combinations of quilting speed and stitches per minute to find what optimally works for you.

To use manual stitching mode

 **ONLINE:** For more information about using manual stitching mode, watch the video *Micro Quilting* at: <http://www.HandiQuilter.com/Amara/microquilting>.

- Touch the **Manual** button and then specify the stitches per minute (SPM) by pressing the plus (+) or minus (-) buttons on the screen or selecting one of the stitches-per-minute presets. Pressing the plus (+) or minus (-) buttons on the screen to change the stitches per minute has the same effect as pressing the plus (+) or minus (-) buttons on the handlebars.

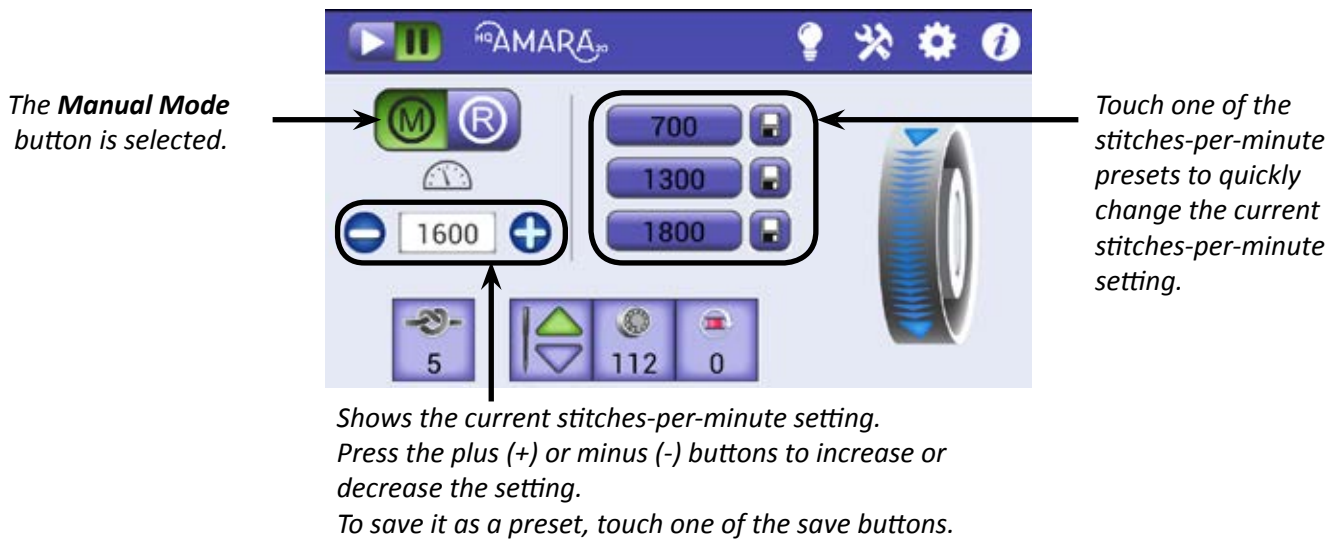

To configure the manual stitching mode preset speeds

The manual mode preset speeds are three different stitches-per-minute speeds, that are saved for quick access from the Main screen. After you set the speeds, you can choose one of the presets when in Manual stitching mode and it becomes the current speed. For example, perhaps you will set one preset for the speed you prefer for continuous line free motion quilting, a different speed for ruler work, and yet another speed for micro quilting.



1. Select Manual stitching mode by touching the **Manual** button.
2. Press the plus (+) button to increase or the minus (-) button to decrease the current stitches per minute setting.
3. Touch the save button next to one of the stitches per minute presets to save the current setting as a preset.

- ✦ **QUILTING TIP:** Set the machine at a medium speed (such as 1000) and begin moving it until you become accustomed to the resistance. By moving the machine faster, the stitches will begin to elongate. The stitch speed can either be increased or the machine can be moved slower to get the stitches at your desired length. By moving the machine slower, the stitches get shorter and can build up on top of each other, break the thread, or make it extremely difficult to unpick. The stitching speed can be decreased, while maintaining a constant motion with the machine to bring the stitches to the desired length.

Stitch Regulation Mode

There are two stitch regulation modes: Cruise and Precision.

To use Cruise stitch regulation

- ✦ **ONLINE:** For more information about using Cruise stitch regulation, watch the video *Micro Quilting* at: <http://www.HandiQuilter.com/Amara/microquilting>.

- Touch the **Regulated** button and then touch the **Cruise** button.

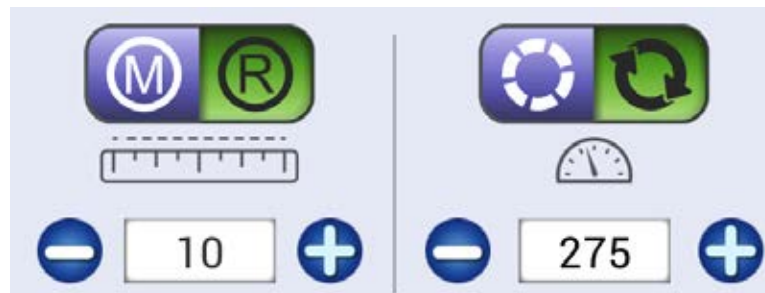

After you press the Start/Stop button on the handlebars, the Start stitching indicator in the upper-left corner of the screen turns green and the needle begins moving up and down according to the cruise speed or stitches-per-minute setting. When you start moving the machine the needle will move according to the stitches-per-inch setting. Similarly, as you bring your quilting to a stop, the needle will continue moving at the cruise speed (stitches per minute) until you press the stop button on the handlebars. The minimum speed of the needle is dependent upon the stitches-per-minute setting you choose. Handi Quilter recommends beginning with a setting of 200. Begin moving the machine immediately after pressing the Start/Stop button to avoid stitching in place for too long.

- ✦ **QUILTING TIP:** The constant minimum stitching speed featured in the Cruise stitch regulation is useful when creating sharp points such as the point of a star or the bottom of a heart.

To use Precision stitch regulation

 **ONLINE:** For more information about using Precision stitch regulation, watch the video *Micro Quilting* at: <http://www.HandiQuilter.com/Amara/microquilting>.





- Touch the **Regulated** button and then press the **Precision** button.

The **Regulated Mode** button is selected.



The **Precision** stitch regulation button is selected.

After you press the Start/Stop button on the handle bars, you must begin moving the machine for it to begin quilting according to the stitches-per-inch setting. The Start stitching indicator in the upper-left corner of the screen turns green but the needle doesn't automatically begin moving up and down. When you begin moving the machine, stitching begins. When you stop moving the machine, stitching pauses until you move the machine again. To stop stitching, press the Start/Stop button on the handlebars.

-  **NOTE:** When using Precision stitch regulation, if you stop moving the machine but do not press the Start/Stop button, after two minutes it will time out and a message box appears to let you know you will need to press the Start/Stop button to resume quilting.
-  **CAUTION:** Always make sure the power is off when changing the needle, replacing the bobbin, or placing your hands near the needle to avoid unwanted stitching in your quilt or in your fingers.
-  **QUILTING TIP: When to use Precision stitch regulation.** Precision stitch regulation mode is useful for ruler work. Stitch along the length of the ruler for the span of your hand and stop moving the machine, but do not press the Stop button. When you stop moving the machine, the needle pauses. Move the ruler and then begin moving the machine to continue quilting. Precision stitch regulation helps you to avoid bobbles and uneven stitches. Precision is also useful for precise backtracking or over-stitching, such as backtracking over the tops of feathers.
-  **QUILTING TIP: Getting started with stitch regulation.** Set the machine to your desired stitch length. Begin moving the machine. The machine motor will slow down or speed up to maintain a consistent stitch length according to how quickly or slowly you move the machine. Moving the machine too fast or in radical or jerky movements will defeat the stitch regulator function.
-  **QUILTING TIP: Quilting speed while in stitch-regulation mode.** Quilting speed while in stitch-regulation it is unlikely that you will move the Amara across the quilt too fast. However, if you do, it will result in an over-speed condition and the machine will not maintain stitch regulation. An over-speed alarm, if turned on, will alert you that you should slow down your quilting to maintain stitch regulation.

Basting Mode

The Amara includes five basting stitch options for basting a quilt. The basting stitch options are available in stitch regulation mode only.

The stitches-per-inch setting ranges between 24 stitches per inch and 5 stitches per inch. If you continue to press the minus (–) button on the screen, after 5 you will see B1/4", B1/2", B1", B2", and B4".

B1/4"	One stitch every quarter inch of movement of the machine
B1/2"	One stitch every half inch of movement of the machine
B1"	One stitch every one inch of movement of the machine
B2"	One stitch every two inches of movement of the machine
B4"	One stitch every four inches of movement of the machine

 **ONLINE:** For more information about basting mode, watch the video *Basting a Quilt* at: <http://www.HandiQuilter.com/basting>.

To baste a quilt

1. Touch the **Regulated** button.
2. Press the minus (–) button next to the stitches-per-inch box on the screen until you see 5 stitches per inch. Continue touching the minus (–) button and the five basting stitch options appear. Choose the one you want to use – either B1/4", B1/2", B1", B2", or B4".
3. Begin basting the quilt by pressing the Start button. As you move the machine across the quilt, it will perform a stitch (needle down and then needle up) every quarter, half, one, two, or four inches according to your choice of basting stitch length.

 **QUILTING TIP:** If you are basting the edges of the quilt to the batting and backing, choose a low number of stitches per inch, somewhere between 4 to 8 stitches per inch, rather than one of the basting-mode stitches. This will help to prevent the hopping foot from going between the batting and quilt top.

Toolbar Options

The toolbar is in the upper-right corner of the screen at all times.

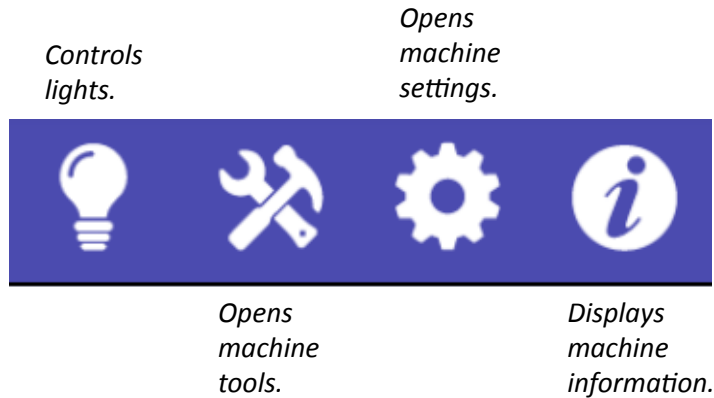

Controlling the Lights

Your Amara comes equipped with three standard lighting areas: throat, needle, and bobbin.

To control the lights on the machine

- To open the Lights screen, touch the **Lights** icon in the Toolbar. After selecting the icon, it turns green and Lights screen opens.

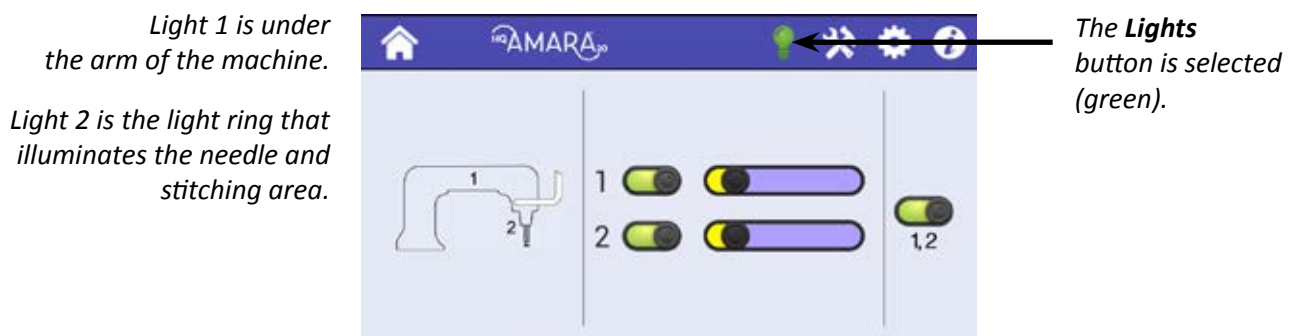

When lights are on, the on/off button displays in color. When off, the button is gray. Touch the on/off button to quickly turn on (or off) the light.



Touch the All Lights (1,2) button to turn on (or off) all of the lights at once.



Use the slider to vary the intensity of the light. Touch the black dot and drag to the right to increase the intensity or to the left to decrease the intensity. The intensity settings are saved when lights are turned off and will be the same when you turn them on again.

Machine Tools

To open the machine tools, touch the **Tools** icon in the Toolbar. After selecting it, the icon turns green.

*The **Tools** button is selected (green).*



Choose from the five tools at the bottom of the screen.

Sets the quilting timer, the stitch counter and the quilting alarm.

Opens the on-screen calculator.

Updates the machine's software.

Zeros the Easy-Set Tension following disassembly.

Opens the Diagnostics Screen.



After you select an option, the button background turns green and the screen changes allowing you to customize that setting. The next time you touch the Tools icon, the last Tools option you used appears.

Quilting Timer, Alarm, and Stitch Counter

The timers screen enables you to track the amount of time you work on a quilt, to set a timer to remind you when your quilting time is up, and to track the number of stitches on a quilt.

 **ONLINE:** For more information about the quilting timer, quilting alarm, and stitch counter, watch the video *Setting and Using the Quilting Alarms and Stitch Counter* at: <http://www.HandiQuilter.com/Amara/alarms>.

- Touch the **Tools** icon in the Toolbar. Then touch the **Timers** button. Press the **Home** button to return to the Main screen.



To track how much time you spend on a quilt

Use the quilting timer to keep track of how much time you spend stitching on a quilt. The quilting timer measures time the machine is actually quilting, not the time the machine is on but idle. It operates like a stop watch.

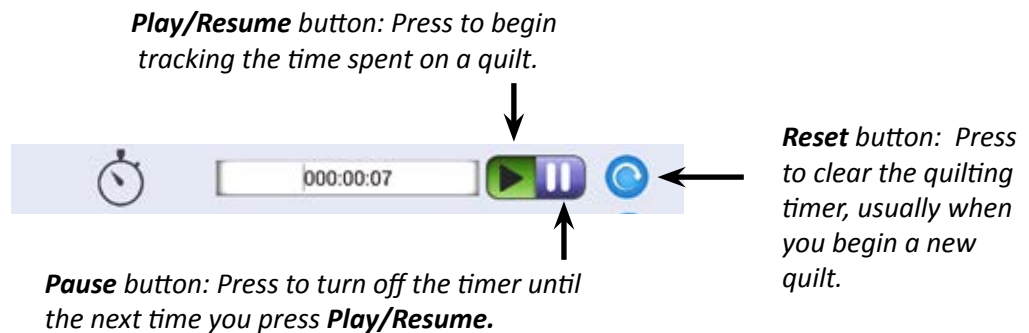

1. When you begin a new quilt, press **Reset**.
2. When you are ready to begin tracking the time spent on a quilt, press **Play**. Proceed with your quilting. When you are through quilting for a time, press **Pause**.
3. When you resume quilting, press **Play** again. The quilting timer will continue tracking your time and add it to the previously recorded time.

To track the number of stitches in a quilt

Use the stitch counter to count the number of stitches in a quilt.

- Press the **Reset** button to zero-out the counter when you begin a new quilt. To see the lifetime stitch count for your machine, see the *Information* screen.



To set the quilting alarm

Use the quilting alarm to set a reminder that alerts you when the time you've allotted for quilting is done. After you enable the alarm, the time begins to count down. Unlike the quilting timer, this alarm measures elapsed time, not machine quilting time. The example below shows only 3 minutes and 55 seconds are remaining before the alarm will sound.



Touch the alarm icon to turn on or off the quilting alarm. It appears green when enabled.

Shows the current quilting alarm setting. Press the plus (+) or minus (-) buttons to change the alarm setting.

1. Specify the amount of time that will elapse before the alarm will go off. Change the alarm setting by pressing the plus (+) or minus (-) buttons which increments the setting by one minute at a time.
2. Touch the alarm icon to turn on the quilting alarm. When the time has elapsed, an alarm will sound.

On-screen Calculator

The Amara includes a basic on-screen calculator. It functions like all basic calculators. For example, press a number button and a function button followed by another number button. Function buttons include addition (+), subtraction (-), multiplication (x) and division (\div). After you've pressed the numbers and the function buttons, press the equal sign (=) for the answer.

- Touch the **Tools** button in the Toolbar. Then touch the **Calculator** button along the bottom of the screen. Press the **Home** button to return to the Main screen.



*The **Tools** button is selected, or green.*

Software Updates

From time to time Handi Quilter releases a software update for our machines. This update feature enables you to take advantage of the latest new capabilities added to machines. When an update is released, download the updated file(s) to a USB drive using a computer that is connected to the Internet.

- Touch the **Tools** button in the Toolbar on the front display. Then touch the **Update** button along the bottom of the screen.



- After downloading the updated software to a USB drive, insert the drive in the designated USB port on the bottom-left side of the front display. Look for the message in the bottom bar that confirms a USB drive has been inserted. If it doesn't appear, reinsert the USB drive. Then touch the **Update** button. Press the **Home** button to return to the Main screen.



To update the machine's software

- 🔗 **ONLINE:** For more information about updating the machine's software, watch the video *Updating the Software on the Amara* at: <http://www.HandiQuilter.com/videos/Amara/update>.
- 🔔 **IMPORTANT:** If you are running the Amara from a Pro-Stitcher tablet computer, the Update screen has only the machine icon because you update the machine software only. The Amara display software is part of the Pro-Stitcher software. Make sure you are also using the latest version of Pro-Stitcher.

To update the machine software

1. Insert the USB drive into the USB port on the bottom-left side of the front display. Then touch the machine icon to update the machine's software.



2. You will be prompted to choose the file you want to use to update the machine software. Touch the **Select Version** box and then select the filename of the update file you downloaded.



3. Be patient as this will take a few minutes.

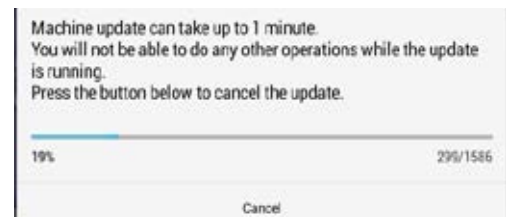

4. When complete, the machine will beep. Remove the USB and restart the machine.

To update the display software

You will need to update the display on both the front and rear.

1. After inserting the USB drive into the USB port on the bottom-left side of the display, touch the display icon to update the display's software.

 **NOTE:** To update the rear display, insert the USB drive with the update into the bottom-left side of the rear display. After updating, remove the USB drive from the display.



2. You will be prompted to choose the file you want to use to update the display software. Touch the **Select Version** box and then select the filename of the update file you downloaded.



3. When the message box appears, select **New** and **Install**.

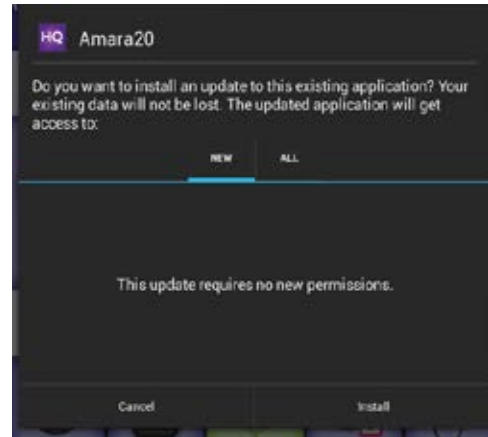

4. Be patient as this will take a few minutes.

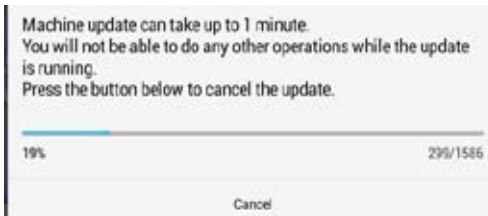

5. Confirm that you want to overwrite the current software with the new software by choosing **Install**. If you decide to not update the software, choose **Cancel**.

Diagnostics

There are several diagnostics tests that you may be asked to perform by Handi Quilter's technical solutions team or an authorized Handi Quilter representative. They will give you a code to enter into the Diagnostics screen to be able to perform the tests.

- Touch the **Tools** button in the Toolbar. Then touch the **Diagnostics** button along the bottom of the screen. Enter the code you received and follow the instructions for the different diagnostics tests.

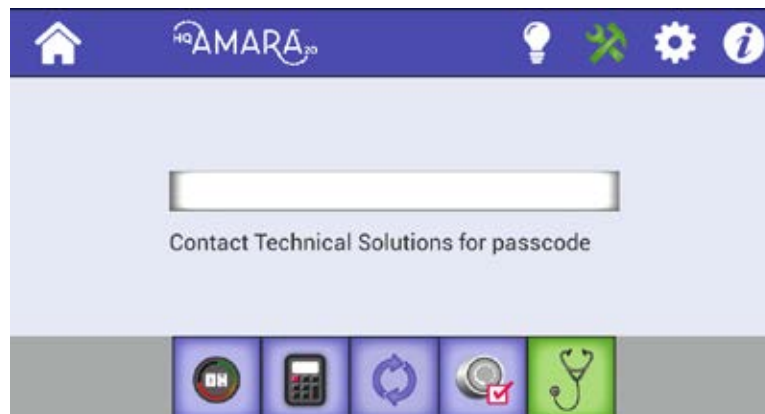

Contact your local representative or Handi Quilter technical solutions at +1 (801) 292-7988 or 1-877-MY-QUILT (697-8458).

Machine Settings

To open the machine settings, touch the **Settings** icon in the Toolbar. After selecting it, the icon turns green.



Then choose one of the seven options that appear along the bottom of the screen.

After you select an option, the button background turns green and the screen changes allowing you to customize that setting. The next time you touch the **Settings** icon, the last Settings option you used appears.

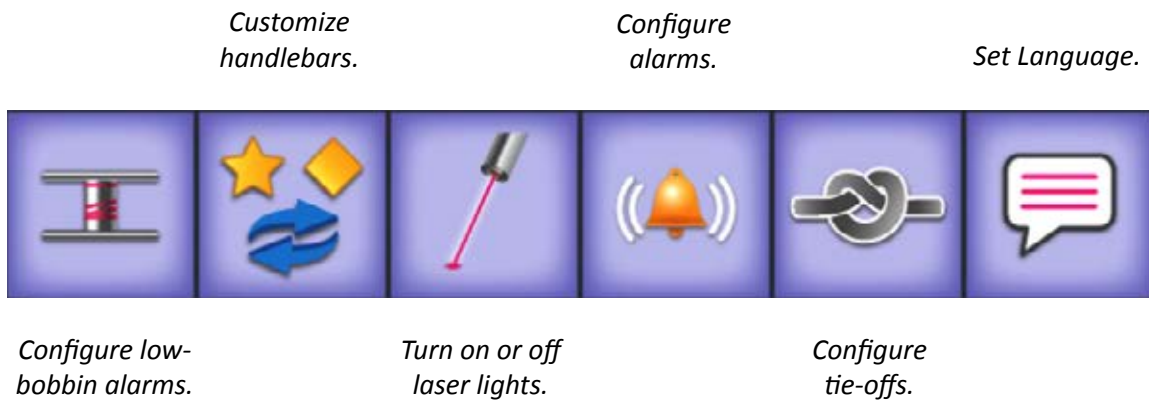

- Press the **Home** icon in the upper left corner of the screen to close **Settings** and return to the Main screen.

Low-Bobbin Alarm

The amount of thread that fits on a bobbin varies according to the type and weight of thread you use. You can create a low-bobbin capacity for up to twenty types of thread that you use in your bobbin. You'll then use this capacity for setting a low-bobbin alarm to alert you to when the bobbin thread is running out.

- **ONLINE:** For more information about using the low-bobbin alarm and customizing the low-bobbin presets, watch the video *Using the Low-Bobbin Alarm* at: <http://www.HandiQuilter.com/Amara/lowbobbin>.

- Touch the **Settings** icon in the Toolbar. Then touch the **Low-bobbin Alarm** button.

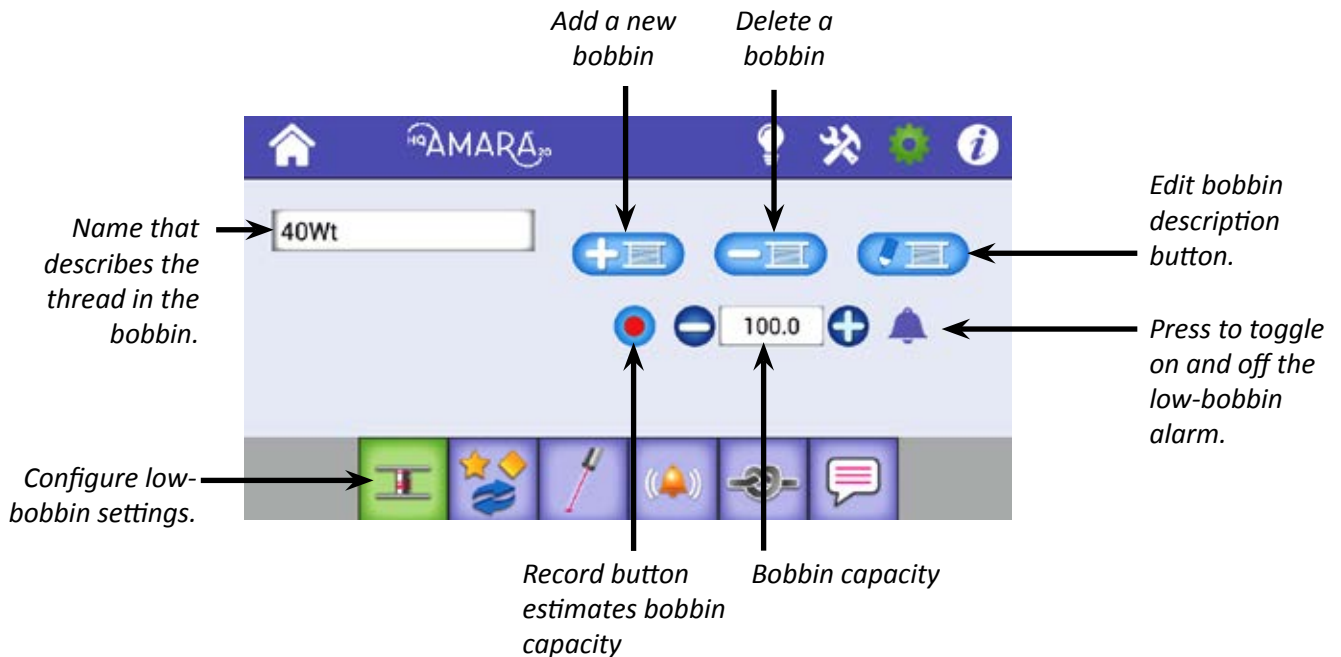

To add new bobbin configuration and record bobbin capacity

1. When you are ready to define a new bobbin capacity for a particular type of thread, completely fill a bobbin with that thread and insert it into the machine.

2. Touch the icon to add a new bobbin. Use the pop-up keyboard to enter a descriptive name, so you will know which type of thread this configuration applies to. Close the pop-up keyboard by touching the arrow in the lower-left corner of the screen.



3. Touch the **Record** button. The bobbin capacity value will reset to zero. Quilt until the bobbin runs out.

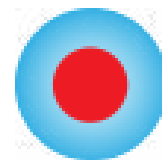

NOTE: The Reset Bobbin button on the Main Screen shows the bobbin level as you quilt. When you touch the **Reset Bobbin** button, it shows the estimated capacity of the full bobbin. As you quilt, this number counts down. While you are recording the bobbin capacity of a bobbin, the number increases as you quilt until it runs out of thread.

4. Return to the low-bobbin alarm screen and press the **Record** button again to stop recording. The number that appears in the Bobbin Capacity box is an estimate how much thread is on the bobbin.



5. Estimate how much bobbin thread you think you'll use for tie-offs and decrease the bobbin capacity by that much. Press the **Minus (-)** button to decrease the capacity. Or, touch the **Bobbin Capacity** box to pop up an on-screen number pad and enter the number directly.

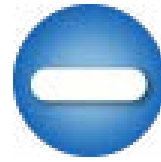

6. When you are ready to use a full bobbin with that type of thread, insert the full bobbin and press the **Reset Bobbin** button on the Main screen



7. Make sure the alarm icon is enabled (green). If not, touch the **Alarm** icon to toggle it on. When the bobbin level reaches zero, the low-bobbin alarm will sound.



 **NOTE:** If you turn on or off the low-bobbin alarm on this screen, it is also turned on or off on the Alarms screen.

The next time you use one of the threads for which you've set up a low-bobbin threshold, touch the bobbin name box and choose the specified thread name by touching it. Insert a full bobbin with that thread into the machine and press the **Reset Bobbin** button on the Main screen.

To delete a low-bobbin configuration

- Touch the **bobbin name** box and choose the specified thread name by touching it. Then touch the **Delete Bobbin** button.

To edit a low-bobbin configuration

- Touch the **bobbin name** box and choose the specified thread name by touching it. Then touch the **Edit Bobbin** button. Make any changes using the pop-up keyboard.

Handlebar button options

Your Amara came with labels for the handlebars unattached, because you can decide which functions you want on the right and left handlebars. For example, most machines are set up with the Start/Stop button on the right handlebar. If you are left handed you may want to use the left handlebar for starting and stopping your quilting and the right handlebar for the needle up/down button. For more information about the handlebar labels, see To attach labels to the handlebars in the Installation and Setup section of this manual.

After you have placed the labels on the handlebars, use the handlebar customization settings to confirm your handlebar button choices and to customize the functions of the star and diamond buttons on the handlebars.

- ➡ **IMPORTANT:** However you configure the front handlebars, the rear handlebars are automatically configured the same way.

To customize the handlebar buttons

- Touch the **Settings** icon in the Toolbar. Then touch the **Configure Handlebars** button. Return to the Main menu at any time by touching the **Home** button.

To switch the left and right handlebar buttons

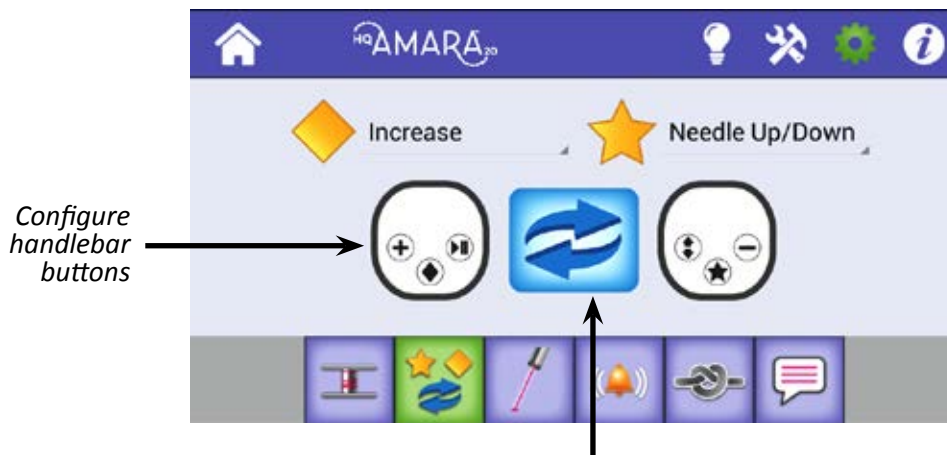

Press to switch the button configurations to match how you placed the labels on the handlebars. The left button image represents the left handlebar; the right button image represents the right handlebar.

- Press the **double-arrow** icon in the center of the screen to switch the options available for the left and right handlebars. Make sure that the handlebar labels are consistent with your selection.
- 🔗 **ONLINE:** For more information about Programming Handlebar Buttons, watch the video *Programming Handlebar Buttons* at: <http://www.HandiQuilter.com/Amara/programminghandlebars>.

To configure the star and diamond buttons on the handlebars

*Touch the **star or diamond** to select the function from the drop-down menu.*



1. Select the **down arrow** next to the star or diamond to display a drop-down box with the options for the star and diamond buttons.
2. Touch your selection for the button.

The options for customizing the star and diamond buttons are:

Option	Action Performed
None	The button will not perform a function.
Start/Stop	Starts or stops stitching
Needle Up/Down	Performs a half stitch by cycling the needle up or down
Increase	Increases stitching speed in manual or SPI in regulated
Decrease	Decreases stitching speed in manual or SPI in regulated
Tie-Off	Performs a tie-off stitch

➡ **IMPORTANT:** If you use Pro-Stitcher, it will override your settings for the star and diamond handlebar buttons for selected Pro-Stitcher functions. For more information about using Pro-Stitcher with the Amara, refer to the Pro-Stitcher user manual.

Needle Laser

The Amara comes equipped with a needle laser. It precisely shows where the needle will enter the quilt. Turn the laser on or off with the Laser settings.



To turn the laser on or off

- Touch the **Settings** icon in the Toolbar. Then touch the **Laser** button. Touch the **toggle button** to turn the laser on or off.



Touch the **toggle button** to turn the laser on or off.



Control the needle laser.
Light is currently on.

Alarms

The alarm settings enable you to quickly turn on or off the alarms for the low bobbin, thread breaks, and over-speed.

Low-bobbin alarm: Alerts you when the low-bobbin threshold has been reached, indicating you will soon run out of bobbin thread. For more information about the low-bobbin alarm, see *Low-Bobbin Alarm* above.

Thread-break alarm: Alerts you if the top thread breaks while quilting.

Over-speed alarm: Alerts you if you are moving the machine faster than 100% of motor capacity and therefore are quilting too fast for stitch regulation to work properly. Because of the high speeds that the Amara can handle, you will most likely never encounter this alarm.

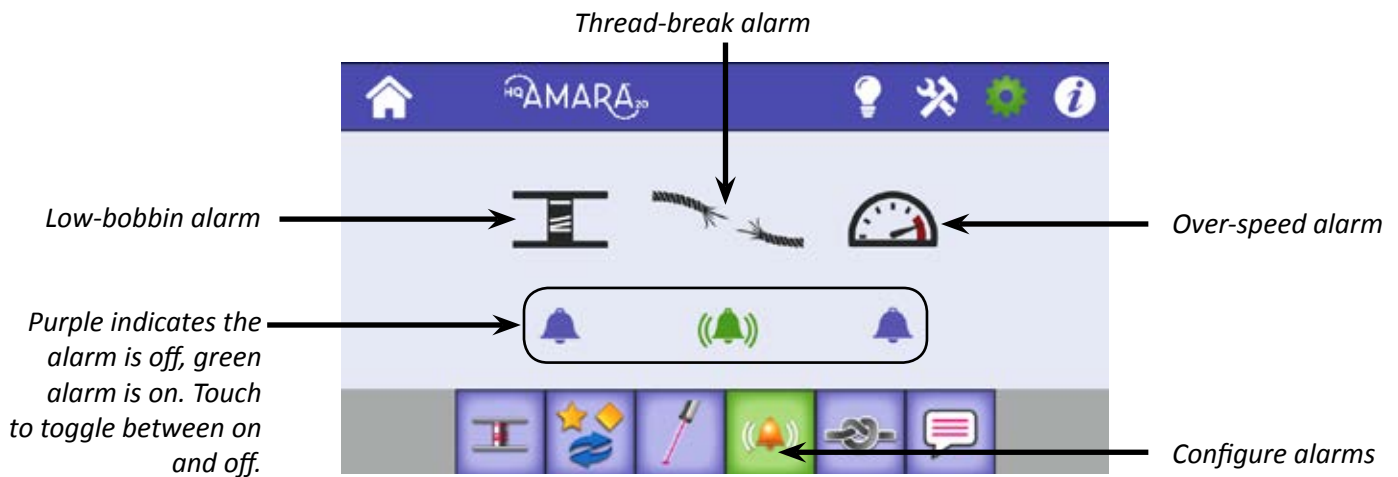

To turn on or off alarms

- Touch the **bell** button below the alarm to turn it on or off. It is on when it appears green with the sound-wave symbols. It is off when it appears purple.

Tie-offs

Use tie-offs to begin and end your quilting to ensure the stitching doesn't come out. You can manually do the tie-offs by simply stitching a few very tiny stitches, or let the Amara perform a predefined number of quick, micro stitches for you. You can set the number of micro stitches from 2 to 10.

To configure tie-offs

 **ONLINE:** To see how to tie off the thread, watch the video *Bringing up the Bobbin Thread at:* <http://www.HandiQuilter.com/Amara/tieoff>.

- Touch the **Settings** icon in the Toolbar. Then touch the **Configure Tie-offs** button. Press the **plus (+)** or **minus (-)** buttons to increase or decrease the number of micro stitches in a tie-off.



After you indicate how many stitches are in an automatic tie-off, use the Tie-off button on the Main screen to perform the tie-off. Touch the button and gently move the machine to perform the micro stitches.

Set Language

The language setting determines the language used on the Amara information screens. The choices are English, French, German, and Spanish.

To select a language

- Touch the **Settings** icon in the Toolbar. Then touch the **button** to set the language. Press the **down arrow** to display the list of available languages. Touch your preferred language to select it.



Information Screens

The Information option provides system information and quick reference guides about your Amara.

To see the needle and thread chart

For quick reference, the Amara has an on-screen guide for which size needle is appropriate for different weights of thread.

- Touch the **Information** icon in the Toolbar. Then touch the **Needle** button.

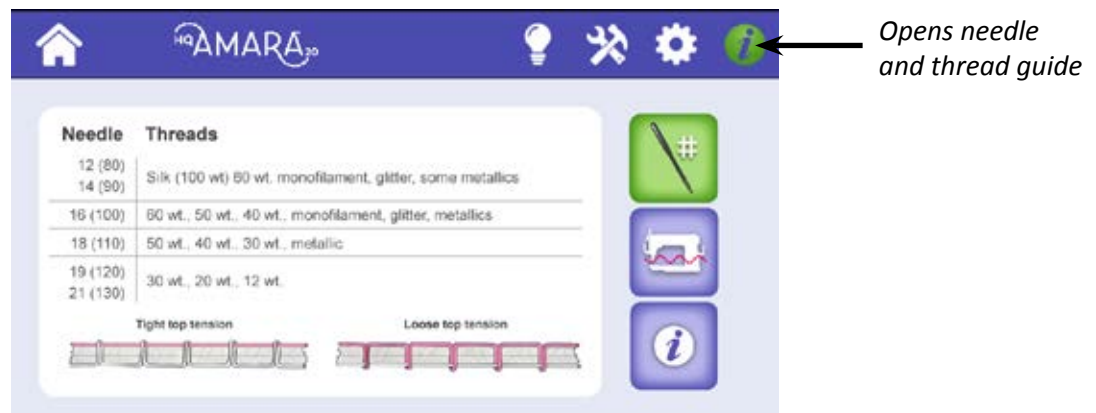

To see the machine threading diagram

For quick reference, the Amara has an on-screen guide that shows how to thread the machine. For more information about threading the Amara, see *Threading the Machine* in the *Using Your Machine* section of this manual.

- Touch the **Information** icon in the Toolbar. Then touch the **Machine Threading** button.

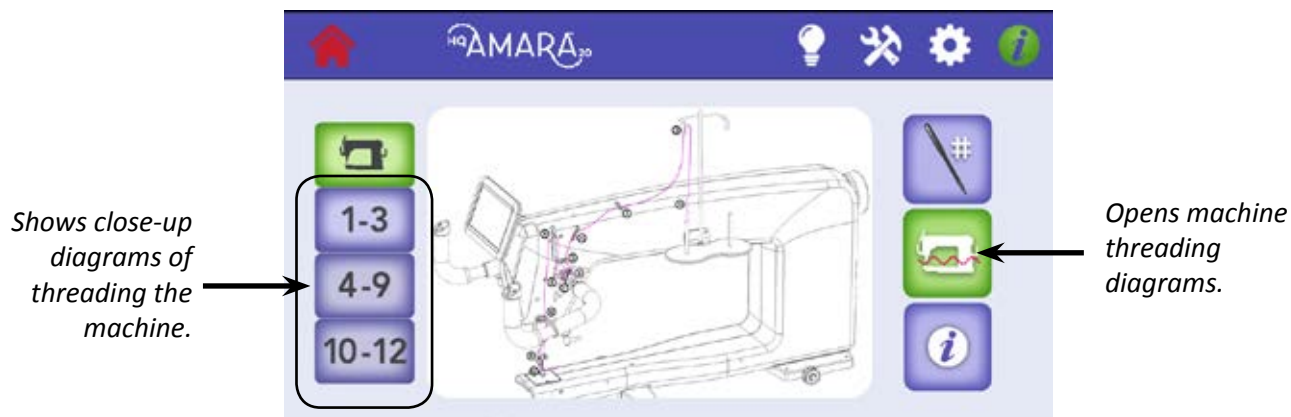

Select one of the buttons along the left to see close-up diagrams of steps 1 through 3, 4 through 9, and 10 through 12.

1-3

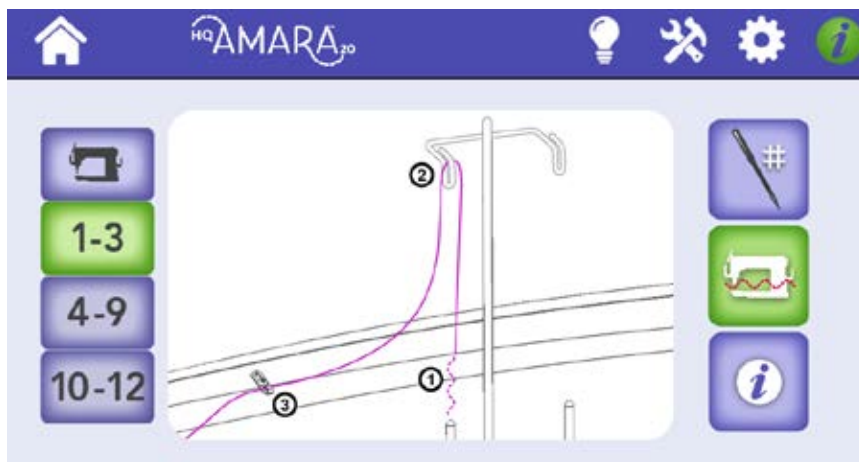

4-9

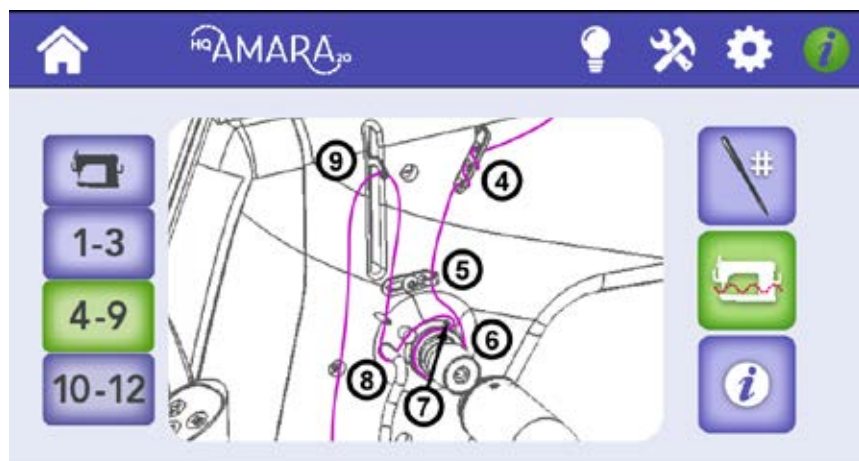

10-12

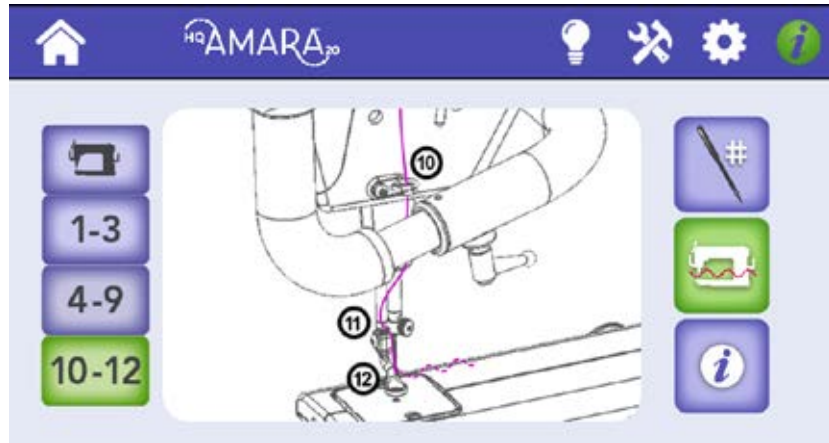

To monitor system information about your machine

You may need to provide system information to Handi Quilter or an authorized Handi Quilter representative when purchasing machine accessories or receiving technical assistance.

- Touch the **Information** icon in the Toolbar. Then touch the **Information** button.

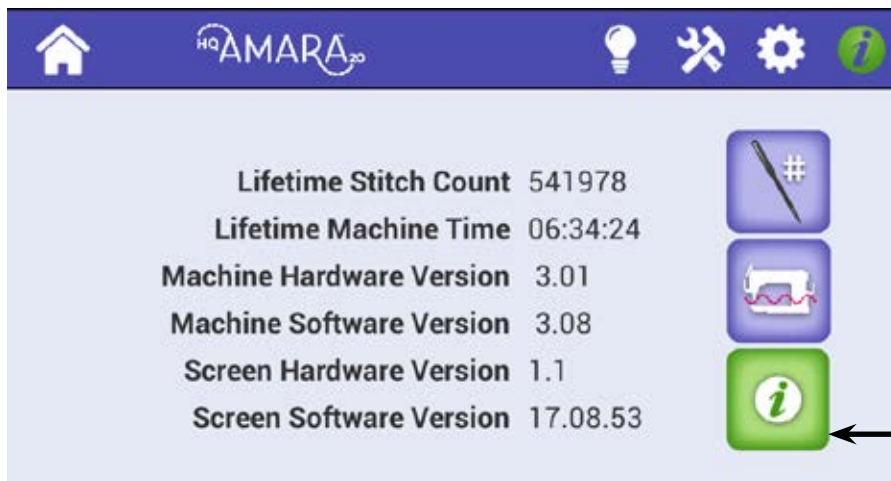

Opens system information about the machine.

Lifetime Stitch Count	Shows the lifetime stitch count for your machine
Lifetime Machine Time	Shows the cumulative time your machine has quilted
Machine Hardware Version	Shows the electronics board version number
Machine Software Version	Shows the machine's software version number
Screen Hardware Version	Shows the screen's version number
Screen Software Version	Shows the screen's software version number

Machine Maintenance

Clean and Oil Your Amara

The only place where you need to regularly oil your machine is the bobbin hook assembly. Failure to keep the hook assembly lubricated can cause severe damage to the machine. We recommend that you oil the hook assembly with each bobbin change and before use if you haven't used the machine for a few days. A change in the sound of the machine while quilting also indicates that it may need to be oiled.

 **NOTE:** Internal oiling needs to be done when the machine is taken to a service technician for routine maintenance and cleaning, every 24 months or 10 million stitches (whichever comes first).

 **IMPORTANT:** Only use light sewing machine oil on the hook when oiling your machine.

To clean the bobbin area and oil the bobbin hook

 **ONLINE:** To see how to clean and oil the bobbin area, watch the video *Bobbin Tension and Maintenance* at: <http://www.HandiQuilter.com/Amara/bobbintension>.

1. Turn off the machine by powering off the front switch. Then remove the bobbin and bobbin case.
2. Clean the bobbin basket area using a lint brush.
3. Put a small drop of oil on the hook in the region where the bobbin basket assembly and the rotating hook meet. The oil will work its way back into the interlocking area of the hook and bobbin basket.

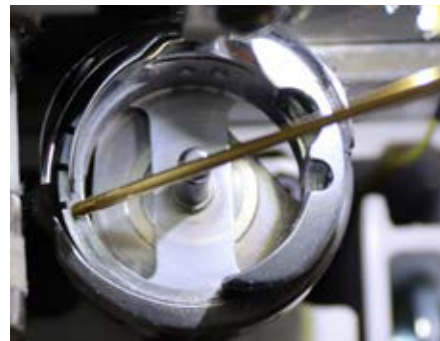

4. Replace the bobbin and bobbin case and turn on the machine.

 **QUILTING TIP:** After oiling, always sew on a scrap piece of fabric off to the side of the quilt as oil may cling to thread. Over-oiling can cause excess dripping from the bobbin assembly.

To clean the touch-screen display

- Use a soft rag or microfiber cloth dampened with isopropyl alcohol and then gently wipe the display to remove any dust or finger marks.

 **CAUTION:** Never use any chemicals to clean your display as this may negatively affect the display's touch-screen response.

Maintenance Schedule

In addition to the ongoing cleaning and oiling maintenance, you should have your machine serviced by an authorized Handi Quilter representative every 24 months or 10 million stitches, whichever occurs first. They will take care of oiling and greasing internal parts and ensure the machine is in tip-top working order. When your machine reaches 10 million stitches, a pop-up message appears to remind you to have your Amara serviced.

Troubleshooting

You can correct many problems on your own. If you need additional help, contact your local, authorized Handi Quilter representative. You can also contact Handi Quilter technical solutions at 1-801-292-7988 or 1-877-MY-QUILT (697-8458).

First check the following:

1. The AC power cord is properly connected and both power switches are turned on.
2. Confirm that all cables are properly seated into their connections.
3. Turn off the machine completely. Wait for at least ten seconds and then turn it back on.

If the above checks did not solve the problem, refer to the information below.

Skipped Stitches	Corrective Measure(s)
The needle is damaged, dull, bent, or installed improperly	<ul style="list-style-type: none"> • Replace the needle often, normally once or twice per day for continuous quilting or at least once per quilt. Use only the recommended needle system. • Always change the needle if the needle has struck any hard object such as a pin, etc. The tip of the needle can become damaged or burred, resulting in fabric damage as well as skipped stitches, thread breakage, or shredding. • Always change the needle if it has been hit, bumped or pulled off center while maneuvering the machine over the quilt. A slightly bent needle can be a major cause of skipped stitches.
Incorrect needle size	<ul style="list-style-type: none"> • Use the proper size needle for the work and thread being used. Some battings and fabrics used in quilting may constrict or impede the thread passing through the front groove of the needle. This diminishes the loop required for stitch formation. Typically, a larger needle will solve the problem. However, using certain smaller sizes of needles and ball pointed needles solve some specific problems. You will need to experiment to determine which works best with your combination of fabric, thread, and batting.
Fabric is too tight on the frame	<ul style="list-style-type: none"> • Loosen the pole tension on the frame. Fabric that is tensioned too tightly causes the fibers to separate and the fabric to bounce while quilting. This reduces the needle friction on the thread, resulting in a smaller thread loop.
Thread tension too tight	<ul style="list-style-type: none"> • Check bobbin case tension and then check top thread tension. (For more information about adjusting tension, see <i>Bobbin and Bobbin Tension</i> and <i>Easy-Touch Tension™</i> in the <i>Using Your Machine</i> section of this manual.)
Improper threading	<ul style="list-style-type: none"> • Ensure that the machine is threaded correctly. Refer to the on-screen threading guide if needed.

The needle is not positioned properly	<ul style="list-style-type: none"> • Position the needle properly to the needle bar. Inspect the position of the needle to make sure the needle is at the 6 o'clock position. When you stand directly in front of the needle (facing the bobbin case side of the machine), you will see the entire needle eye directly facing you. This is 6 o'clock position. • Make sure (a) the needle is installed all the way into the needle bar to the needle-stop hole, (b) the long groove in the needle is toward the front (bobbin case side), and (c) the scarf (scooped out part of the back of the needle) is toward the back of the machine. • The needle can sometimes be rotated to 5 o'clock (slightly right) or 7 o'clock (slightly left) to adjust for a more positive thread loop pickup by the hook point.
The Needle Breaks	Corrective Measure(s)
The needle is bent or not installed properly	<ul style="list-style-type: none"> • Replace the needle. Make sure that the needle is pushed into the needle bar clamp until it can go no further. Visually check that it is up to the top of the sight hole above the needle bar clamp screw. If the needle isn't installed properly, it can cause damage in the bobbin area and throat plate.
The needle hits the throat plate	<ul style="list-style-type: none"> • Correctly position the needle, throat plate, or hopping foot. Replace with a new needle.
Stitches are Puckered	Corrective Measure(s)
The tension is not balanced	<ul style="list-style-type: none"> • Balance the tension of the needle thread after ensuring the bobbin tension is adjusted correctly. (For more information about adjusting tension, see <i>Bobbin and Bobbin Tension</i> and <i>Easy-Touch Tension™</i> in the <i>Using Your Machine</i> section of this manual.)
Needle too large for quilting fabric	<ul style="list-style-type: none"> • Replace the needle with a size better suited for the fabric.
Poor Stitch Quality	Corrective Measure(s)
The tension is not balanced	<ul style="list-style-type: none"> • Balance the tension of the needle thread after ensuring the bobbin tension is adjusted correctly. (For more information about adjusting tension, see <i>Bobbin and Bobbin Tension</i> and <i>Easy-Touch Tension™</i> in the <i>Using Your Machine</i> section of this manual.)
Bobbin case is damaged, corroded, dirty, etc.	<ul style="list-style-type: none"> • Since thread slides over the surface of the bobbin case at a high speed, make sure the case is free of any lint or foreign matter that could impede thread passage through the machine.
Moving the machine too fast for needle speed selected (Manual mode)	<ul style="list-style-type: none"> • Synchronize machine movement and needle speed to get your desired stitch length. Elongated stitches are an indication of moving the machine too fast for the current speed.

Tension is Poor	Corrective Measure(s)
Lint caught under the tension spring in the bobbin	<ul style="list-style-type: none"> If using short staple threads, inexpensive, or industrial threads, or coated threads, lint and other material will build up under the tension spring and begin to lift the spring, reducing the spring's ability to compress against the thread. Insert a pin or the corner of a business card under the spring and clear out the lint. The bobbin tension will return fairly close to its preset tension. Test the tension before quilting.
Hand Wheel Won't Rotate	Corrective Measure(s)
Thread is entangled and caught in the hook	<ul style="list-style-type: none"> There may be a thread lock. With the machine on, use the on-screen hand wheel to break the thread lock. Quickly move your finger down and up several times. If this doesn't solve the problem, turn the machine off and use the hand wheel at the back of the machine to resolve the thread lock.
There is a thread lock.	<ul style="list-style-type: none"> Carefully rock or turn the hand wheel in direction of motion and then the other direction until the thread lock breaks free. Once the hand wheel can be turned freely, remove the thread from the hook and basket. Now re-oil the hook and make sure the hand wheel turns freely without the hook hitting the needle. It is possible for a thread lock to cause a timing problem.
Thread Nests Under Quilt	Corrective Measure(s)
Not enough tension on top thread	<ul style="list-style-type: none"> Check that the machine is threaded correctly. Make certain that the thread is flossed snugly in place between the two tension discs. If the machine is threaded correctly, tighten top tension by rotating the tension knob clockwise. (For more information about adjusting tension, see <i>Bobbin and Bobbin Tension</i> and <i>Easy-Touch Tension™</i> in the <i>Using Your Machine</i> section of this manual.)
Improper threading	<ul style="list-style-type: none"> Refer to threading diagram and threading instructions.
Thread Backlash	Corrective Measure(s)
Bobbin thread tangles within the bobbin case, tangles and winds onto the hook spindle, or occasionally forms loops on the bottom of the quilt	<ul style="list-style-type: none"> Make sure the bobbin is in the bobbin case correctly and the thread is coming out from under the tension spring. The bobbin should rotate clockwise when the thread is pulled.
Hard to Guide Machine	Corrective Measure(s)
Carriage wheels not centered on track	<ul style="list-style-type: none"> Center the carriage wheels on top of the continuous track. Check that the machine carriage has not jumped the track.
Thread caught in wheels	<ul style="list-style-type: none"> Remove all thread or debris in wheels. Check that the tracks are free of lint and threads.

Motor Fails to Run	Corrective Measure(s)
On/Off switch turned off	<ul style="list-style-type: none"> • Make sure that both power switches are turned on. First turn on the rear power switch (to the 1 position); then turn on the power button on the front-left side of the machine.
Machine not receiving power	<ul style="list-style-type: none"> • Check that the power connector is securely plugged into the back of the machine and the three-prong end is plugged into the power source.
Uneven Quilt Design	Corrective Measure(s)
Take-up rollers may be bowed or bent	<ul style="list-style-type: none"> • Make certain the fabric is not rolled too tight, causing the poles to bow. Check that poles are inserted completely together with the push pins engaged so bowing won't occur.
Leaders are stretched or worn	<ul style="list-style-type: none"> • If fabric is beginning to stretch or fray, contact Handi Quilter to purchase replacement leaders.
Thread Breaks	Corrective Measure(s)
Thread is poor quality or may have severe twisting or thread rot	<ul style="list-style-type: none"> • Look for severe twisting of threads when approximately 12 to 15 inches has been pulled off, with the ends pinched together. Cotton threads are particularly susceptible to dry rot or wet rot which makes thread brittle. Do not use poor quality thread, or thread that is rotted or brittle.
Top and bobbin tensions not balanced	<ul style="list-style-type: none"> • Balance the tension of the needle thread after ensuring the bobbin tension is adjusted correctly. (For more information about adjusting tension, see <i>Bobbin and Bobbin Tension</i> and <i>Easy-Touch Tension™</i> in the <i>Using Your Machine</i> section of this manual.)
The machine head has been threaded incorrectly or thread spools are not positioned correctly	<ul style="list-style-type: none"> • Check that the machine is threaded correctly. • Inspect for accidental double wrapping of thread on thread guides. • Inspect the thread mast, making sure the eyelets of the mast are directly over the spools. • Inspect the vertical positioning of the thread cones. Tipped cones can dramatically affect thread tension and can cause breakage.
Debris in tension discs	<ul style="list-style-type: none"> • Inspect for particles and remove any fuzz or debris.
Bobbin rotation is not smooth	<ul style="list-style-type: none"> • Change the bobbin. The slightest hesitation of the bobbin rotation can be the cause of dramatic tension change and thread breakage.
Needle is burred, bent or dull, or installed incorrectly	<ul style="list-style-type: none"> • Change the needle at least once per quilt. Make sure the needle is installed to the top of the stop hole in the needle bar.

Needle not suitable for thread	<ul style="list-style-type: none"> • Replace the needle to one better suited for the thread. Use the proper size needle. Refer to on-screen chart.
Hesitating too long at one point in quilting motif	<ul style="list-style-type: none"> • Move more quickly so stitches don't overlap or build up. When starting the machine, begin moving immediately. Sewing in one place too long will cause the thread to break.
Improper needle/hook relationship	<ul style="list-style-type: none"> • Machine timing needs to be checked. Consult an authorized Handi Quilter technician.
Damage or burr at needle hole of throat plate or other thread handling part	<ul style="list-style-type: none"> • If thread is shredding at the throat plate, check for burrs or jagged edges. Gently rub with emery cloth to remove the sharp edge. Consult a repair technician to polish any hard-to-reach or delicate areas, or if the burr is inside the throat.
Wrong type of needle	<ul style="list-style-type: none"> • Use only the needles recommended by Handi Quilter (134, sizes 12 through 21).
Other possible problems	<ul style="list-style-type: none"> • Needle too close to hook, causing friction and possible collision of hook point and needle (causing broken thread). • Needle plate damage • Hook damage • Broken needles or damaged needle bar clamp
Nothing visible on the display	Corrective Measure(s)
Display cables unplugged	<ul style="list-style-type: none"> • Locate the black cables that plug into the touch-screen display and connect to the side of the machine. Make sure both ends are plugged in securely.
Thread Break Sensor	• Corrective Measure(s)
Thread Break Alarm sounds	<ul style="list-style-type: none"> • Thread has broken and alarm is functioning as expected; re-thread the machine.
Thread Break Alarm sounds but the threads are not broken	<ul style="list-style-type: none"> • Re-thread the machine.
Thread Break Alarm sounds but the machine is threaded correctly	<ul style="list-style-type: none"> • If the tensions are not tight enough to make the take-up spring pass by the Thread Break Sensor, then the alarm will sound. Increase the tensions until the take-up spring passes by the sensor. The sensor is located above and to the front of the top tension assembly.

 **NOTE:** If the troubleshooting tips do not eliminate the problem, please consult an authorized HQ retailer.

Appendix 1

Federal Communications Commissions (FCC) Declaration of Conformity (For USA Only)

Responsible Party: Handi Quilter, Inc.
501 North 400 West
North Salt Lake, UT 84054

declares that the product

Product Name: HQ Amara

complies with Part 15 of the FCC Rules. Operation is subject to the following two conditions: (1) this device may not cause harmful interference, and (2) this device must accept any interference received, including interference that may cause undesired operation.

This equipment has been tested and found to comply with the limits for Class B digital device, pursuant to Part 15 of the FCC Rules. These limits are designed to provide reasonable protection against harmful interference in a residential installation. This equipment generates, uses, and can radiate radio frequency energy and, if not installed and used in accordance with the instructions, may cause harmful interference to radio communications. However, there is no guarantee that interference will not occur in a particular installation.

If this equipment does cause harmful interference to radio or television reception, which can be determined by turning the equipment off and on, the user is encouraged to try to correct the interference by one or more of the following measures:

- Reorient or relocate the receiving antenna.
- Increase the separation between the equipment and receiver.
- Consult the dealer or an experienced radio/TV technician for help.

Changes or modifications not expressly approved by the manufacturer or local sales distributor could void the user's authority to operate the equipment.

Canadian Department of Communications Compliance Statement (For Canada Only)

This digital apparatus does not exceed the Class B limits for radio noise emission from digital apparatus as set out in the interference-causing equipment standard entitled "Digital Apparatus", ICES-003 of the Department of Communications.

Radio Interference (Other than USA and Canada)

This machine complies with EN55022 (CISPR Publication 22) /Class B and AUS/NZ 55022/Class B.



Designed by a Quilter, for Quilters.®

501 North 400 West
North Salt Lake, UT 84054
801-292-7988 • 877-697-8458
Email: sales@handiquilter.com
www.HandiQuilter.com

Warranty issues should, whenever possible, first be submitted to the Authorized Representative who completed your service and training. These representatives have been selected for their dedication to customer satisfaction and have been trained in technical service. They also may provide follow-up advice, training, service, accessories, and other services.

HQ Authorized Representatives may offer their own warranties in addition to those offered by the manufacturer, but do not obligate the manufacturer.

HQ Quilting Machine Limited Warranty

Handi Quilter, Inc. (*hereinafter HQ*) offers a limited warranty on the HQ Quilting Machine (*hereinafter "Machine"*) to be free of defects in workmanship and materials under normal use upon the terms and conditions hereinafter set forth:

- (a) **90 day Limited Warranty:** During the first 90 days from date of purchase, HQ will repair any manufacturing defect without charge for parts or labor. All subsequent warranties include parts costs only.
- (b) **5-year Mechanical Warranty:** For any mechanical failure within this period. Manufacturer will provide free replacement parts, customer pays for labor and shipping.
- (c) **5-year Electronic/Electrical Warranty:** The electric/electronic components are warranted to be free from manufacturing defects for five years from the date of purchase. If any defect is reported within this period, manufacturer will provide free replacement parts, customer pays for labor and shipping. The 5-year electronic/electrical warranty will be invalid if the machine is left plugged into a power source when not in use.
- (d) **10-year Limited Manufacturer's Warranty:** HQ warrants the sewing head is free of casting or machining imperfections causing product failure. This warranty does not extend to mechanical or electronic/electrical parts, which are covered under a separate warranty, or consequential damage to the head caused by mechanical or electronic/electrical part failures beyond their warranty period.

The limited warranty stated in sections (b), (c) and (d) above shall be limited solely to the replacement of parts which, in the opinion of HQ, are defective in workmanship or material and are returned to HQ, or an authorized repair facility, or such other point or place that may be designated by HQ. All other costs, including cost of freight and shipment for repair under this warranty, shall be the customer's costs.

The machine registration card must be completed and received by HQ before warranty is valid.

Warranty Exclusions: HQ shall have no obligation for any claim under this warranty if the machine has been misused, abused, neglected, damaged in transit or has been altered from the standard specifications established by HQ, or if proper maintenance and lubrication have not been timely performed.

No warranties extend beyond the express warranty offered. HQ disclaims all other warranties, express or implied, regarding the Products, including any implied warranties of merchantability or fitness for a particular purpose. In the United States, some laws do not allow the exclusion of the implied warranties.

Specific exclusions of warranty limitations include, but are not limited to, the following:

- General, consequential, incidental or special damages including damage to fabric or material, the cost of rework or lost profits, the cost of installation or removal of any Products, and any inspection, testing, or redesign caused by any defect or by the repair or replacement of Products arising from a defect in any Product.
- Products which are received by HQ improperly packaged, altered, or physically damaged.
- Counterfeit or altered label(s) or stickers.
- Broken pins on connectors.
- Stripped screws or nuts.

- Connector(s) damaged, cracked, missing or broken.
- Missing, torn or punctured seal(s).
- Any use besides machine quilting applications using customary fabrics, threads and accessories.
- Operator error in the customary use of the Product.
- Internal adjustments, tampering or parts replacement done by anyone except authorized Representatives or customers specifically authorized by Handi Quilter Customer Support or warranty repair personnel on a case by case basis.

The warranty does not cover and the user assumes the risk of and there is hereby excluded any liability to HQ for failure, defects, loss, deterioration, personal injury or damage which are due to: (1) ordinary wear and tear or exposure, (2) abuse, misuse, negligence, or (3) use of parts not authorized by HQ.

In no event shall HQ be liable to the purchaser of the Machine or to third parties for special or consequential damages, including, but not limited to, death or personal injuries.

HQ does not assume, or authorize any person to assume on its behalf, any other obligation of liability other than that set forth herein.

Some states do not allow exclusion of limitation of incidental or consequential damages, so above limitation or exclusion may not apply. This warranty gives the purchaser specific legal rights and the purchaser may also have other rights, which may vary for State to State.

Exclusive Remedy: Remedy is limited to the repair or replacement of the defective Product. HQ may elect which remedy or combination of remedies to provide at its sole discretion and shall have a reasonable time, after determining that a defective Product exists, to repair or replace the defective product. Replacement Product may be from new or serviceable used parts. HQ's warranty applies to repaired or replaced Products for the balance of the applicable period of the original warranty or ninety days from the date of shipment of a repaired or replaced Product, whichever is longer.

HQ's entire liability for any defective Product shall in no event exceed the purchase price for the defective Product. This limitation applies even if Handi Quilter cannot or does not repair or replace any defective Product.

Service under the above warranties may be obtained by returning the quilting machine, with proof of purchase, to the authorized Representative from whom the machine was purchased, a local Representative, or to Handi Quilter Customer Support.

Any product to be returned to the factory, either by customers or Representatives, must be accompanied by a Return Material Authorization Number (RMA). RMAs may be obtained by email (sales@handiquilter.com) or by calling customer support toll free at 1-877-697-8458. If it is determined that the Product may be defective, an RMA number will be issued with instructions for Product return. An unauthorized return (a return without an RMA number) will be shipped back to customer at customer's expense. Authorized returns are to be shipped prepaid and insured in an approved shipping container. The original box and packaging materials should be kept for storing or shipping.

Shipping Costs: Shipping is the responsibility of the customer.

Product Service and Maintenance: Replace needles every 2 to 4 hours (1 to 2 per large quilt) and lubricate bobbin hook every 3 to 4 hours of use. Periodically check the thread tensioner. Use a small brush to clean out all lint, loose thread or obstructions from the bobbin hook.

Servicing is recommended annually from a qualified Representative. Servicing will cover belt tensioning, encoder positioning, bearing retainers, hook axial play and timing, presser and needle-bar adjustment and internal lubrication to take-up lever, hopping foot levers, bushings/bearings

**Handi Quilter, Inc.
Customer Relations
501 North 400 West
North Salt Lake, Utah 84054**

Handi Quilter Warranty Registration

Mail or Fax completed Warranty Registration Card **within 30 days of purchase**. If you have questions, email HQcares@HandiQuilter.com or call Customer Relations at 1-877-697-8458. Online warranty registration is also available at HandiQuilter.com.

MAIL TO: Handi Quilter, Inc.
Warranty Registration Dept.
501 N 400 W
North Salt Lake, Utah 84054

FAX TO: 801-294-3011

The HQ Quilting Machine warranty is 10 years manufacturer's warranty on casting and machining of the case, 5 years electronic/electrical, and 5 years mechanical. Check with your local HQ Representative for details on service or making warranty claims.

HQ Quilting Machine Model (check one): HQ Sweet Sixteen® HQ Simply Sixteen® HQ Avanté®
 HQ Amara™ HQ Fusion® HQ Infinity®

Customer Name: _____

Company/Business Name (if applicable): _____

Address: _____

City, State, Zip: _____

Daytime Phone: _____ Evening Phone: _____

Fax: _____ Email: _____

HQ Serial Number: _____ Order Number (5 digits): _____

Purchase Date: _____ Date Machine Received: _____

Location of Purchase (Shop or Show name, City & State): _____

Type of use intended: Home/Personal Some commercial Share w/Friends Mostly commercial
 Other _____

Type of machine-quilting skills: Novice Intermediate Experienced

Skill adjusting sewing machines: Novice Intermediate Experienced

Signature: _____ Date: _____

Cut along dotted line and mail or fax this registration information within 30 days of purchase.

This page was intentionally left blank.

HQ Amara New Owner and Training Checklist and Certificate



You are entitled to a one-time free introductory training class on the use of your HQ quilting machine as well as free adjustments for 60 days and any repairs covered by the warranty. Present this checklist to your authorized HQ quilting machine Rep to receive these free services. Retain a copy for your records.

Cut along dotted line and mail or fax this registration information within 30 days of purchase.

Table

- How to adjust length
- How to adjust height
- How to change from Standard load to Clearview load

Machine Setup

- Identify the main parts of the machine
- Ensure machine is properly placed on the carriage
- Check all cable connections
- Ensure power outlet is available and does not cause a trip hazard
- Recommend and explain the importance of a power strip with surge protection
- Ensure the frame is level
- How to wind a bobbin (including how to adjust the tension and the capacity)
- How to load a quilt in both Standard and Clearview modes
- How to adjust the handlebars

Machine Operation

- How to turn the machine on and off (both switches)
- How to change the needle
- How to change the Handi Feet
- How to properly thread the machine
- How to set the bobbin tension; teach the drop test
- How to set the upper tension with Easy-TouchTension
- How to bring up the bobbin thread
- How to tie off (manually and with auto Tie-off)
- How to use the menus: explain each menu
- How to adjust lighting
- How to use the on-screen handwheel
- How to set and use the low bobbin estimator
- Explain timers and stitch counters
- How to switch between stitch regulation and manual mode
- How to set the speed in manual mode; how to set the presets
- How to set the stitches-per-inch in stitch regulation
- How to use Cruise stitch regulation
- How to use Precision stitch regulation
- How to use the handlebars (including setting options for programmable buttons)
- Explain the alarms

Machine Maintenance

- How to oil the bobbin hook: where, how, and when
- How to clean the bobbin hook area
- How to clean wheels and tracks

IMPORTANT: Read before signing

By signing this training checklist you are acknowledging you have been personally instructed in the operation of the HQ Amara machine you purchased. Additional training by this HQ Retailer or any other HQ Retailer may result in being charged for additional instruction.

Customer Name _____

Customer Signature _____

Training Date _____

Trainer Name _____

Retailer Signature _____

HQ Retailer Business Name _____

Business City and State/Province _____

Machine Serial Number _____

HQ Retailer: To register training services provided, return completed and signed certificate by FAX (1-801-294-3011) or MAIL:

Handi Quilter
501 North 400 West
North Salt Lake, UT 84054

This page was intentionally left blank.



Designed by a Quilter, for Quilters.®

Handi Quilter, Inc
501 N 400 W
North Salt Lake, UT 84054

1-877-MY-QUILT (697-8458) • www.HandiQuilter.com

HQ Amara™ is part of the family of innovative quilting products from Handi Quilter®



EDITED NOVEMBER 2017

© 2017 Handi Quilter, Inc. All rights reserved. Printed in the U.S.A.